

Anton40

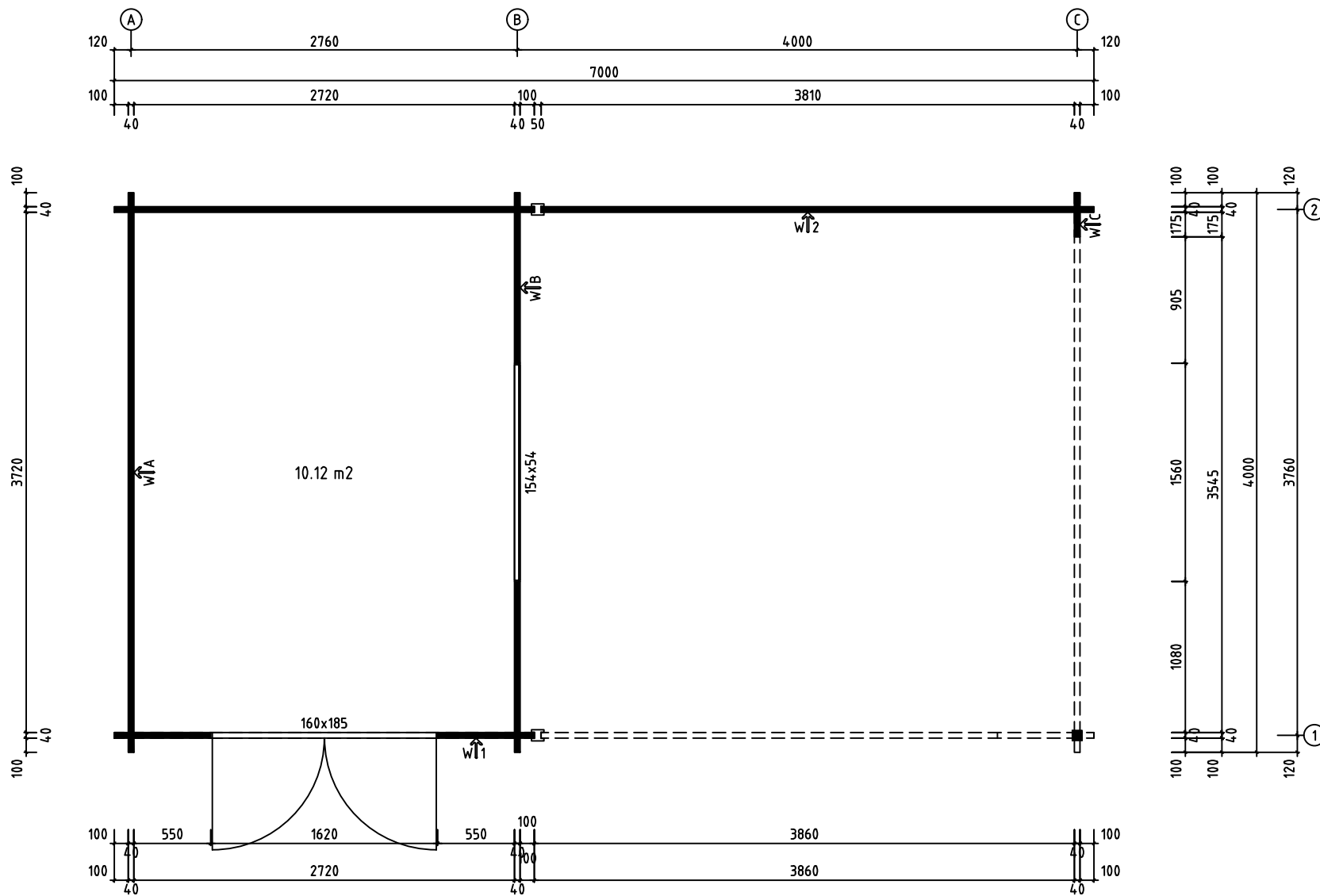

Model	Anton40	Page	
Client		Scale	1:30
Material	4x11.4mm	Date	12.04.2018
Company		File	Anton40.dwg

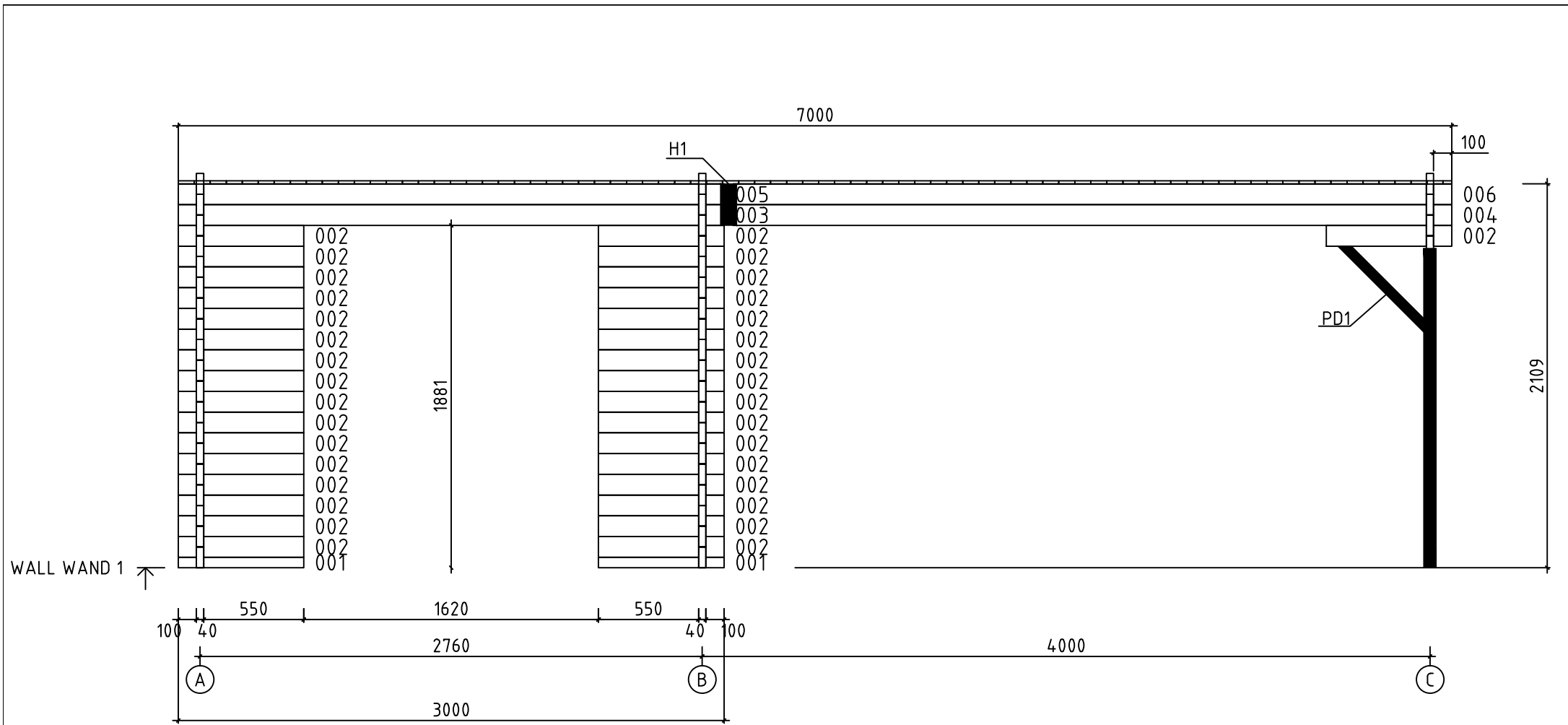

Model	Anton40	Page	5
Client		Scale	1:30
Material	4x11.4	Date	10.11.2016
Company		File	Anton40.dwg

WALL WAND 2 ↑

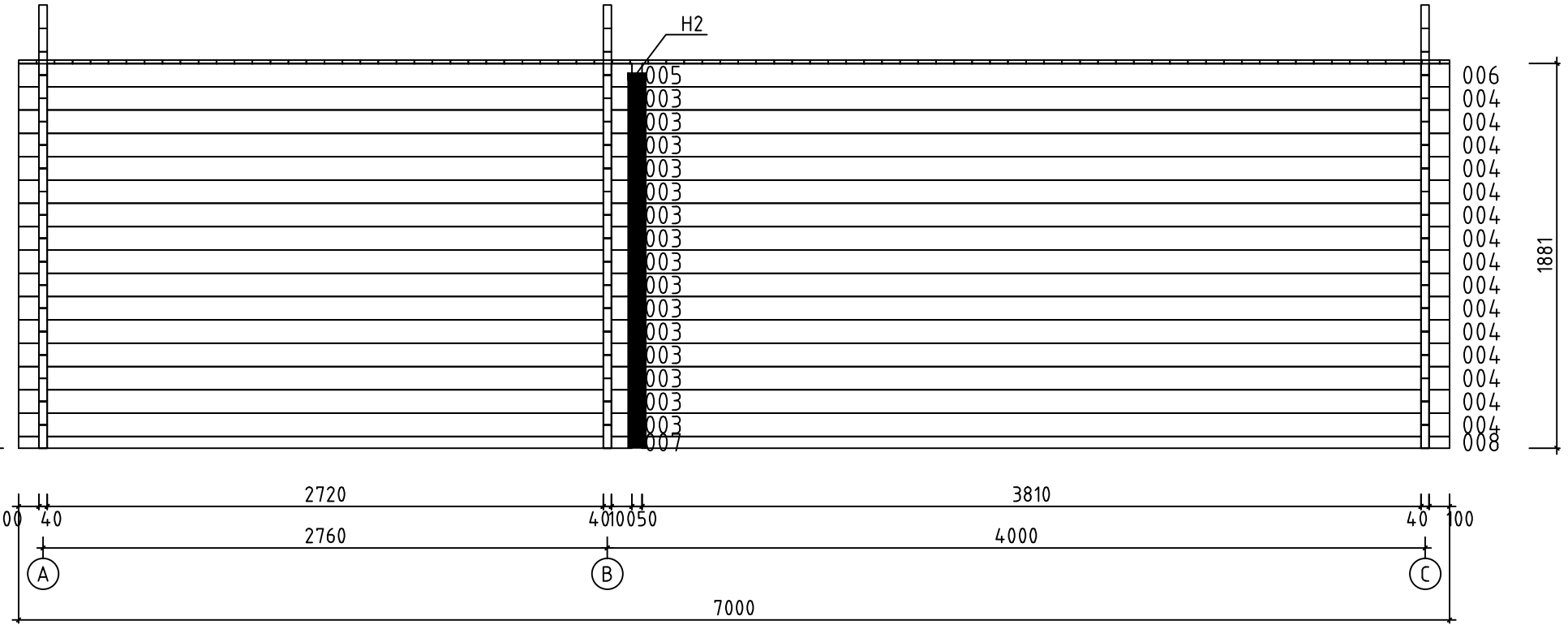

Model	Anton40	Page	6
Client		Scale	1:30
Material	4x11.4	Date	10.11.2016
Company		File	Anton40.dwg

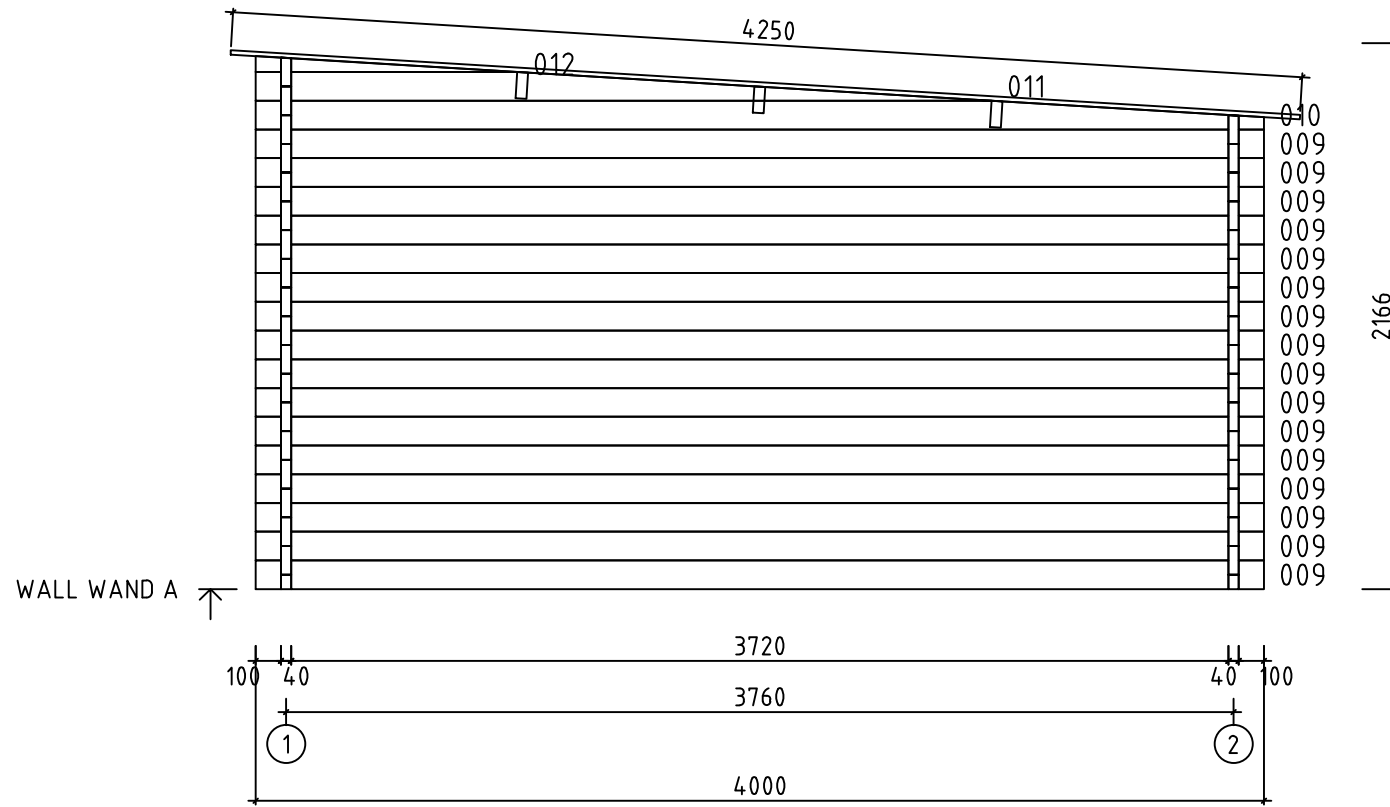



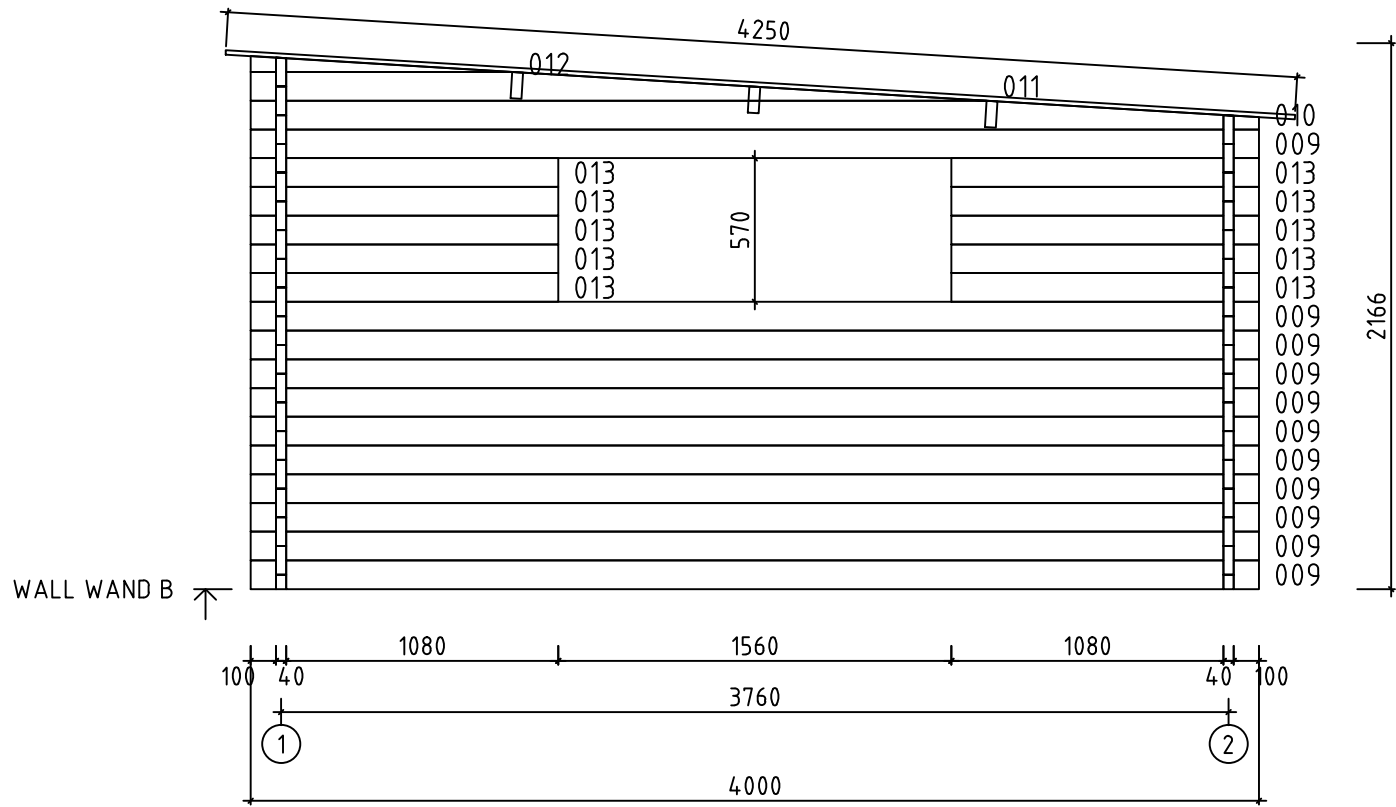



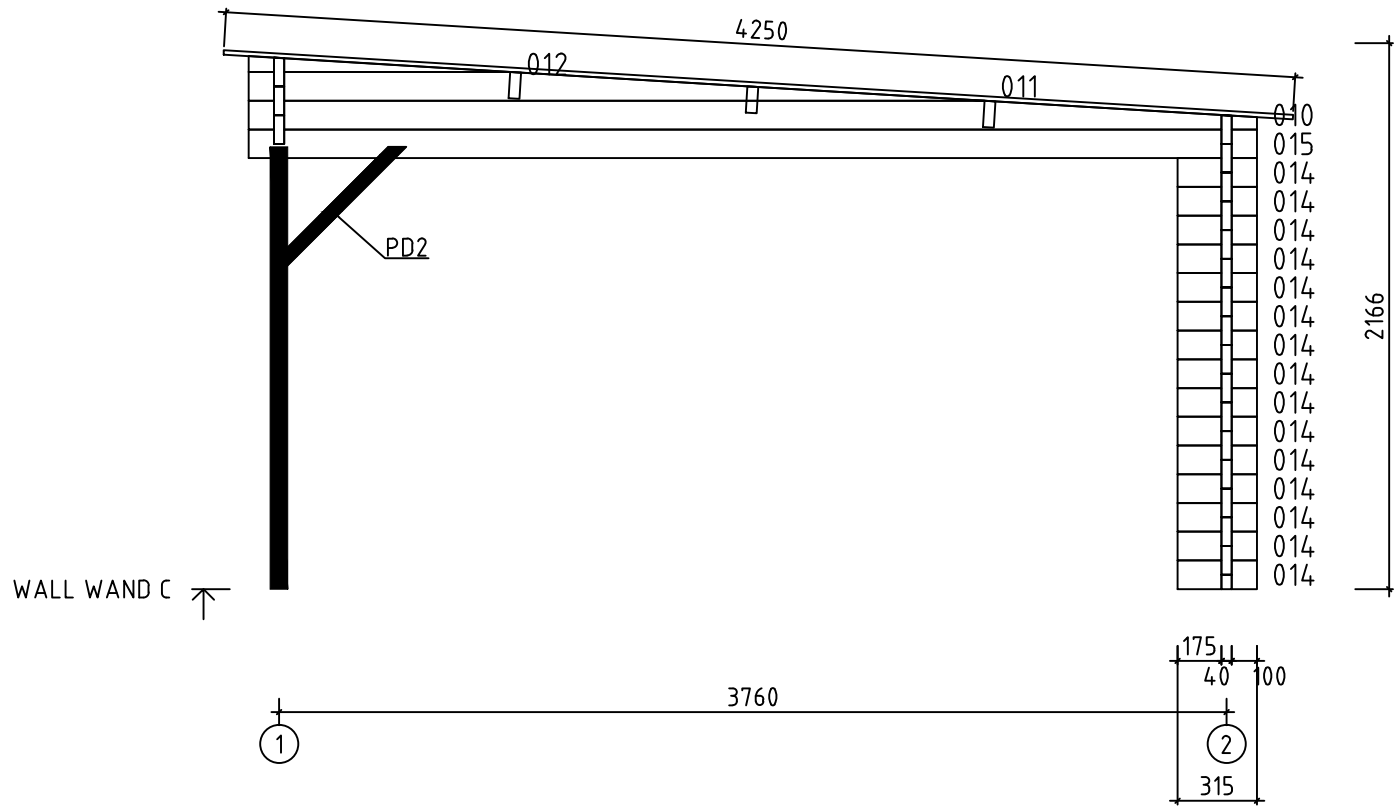

Model	Anton40	Page	2
Client		Scale	1:30
Material	4x11.4	Date	10.11.2016
Company		File	Anton40.dwg

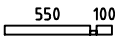
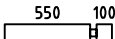
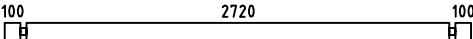
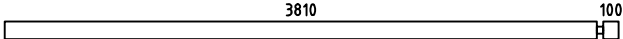
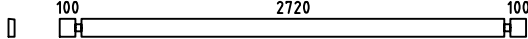
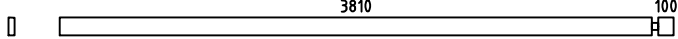
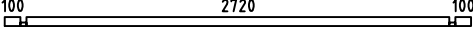
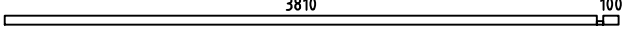
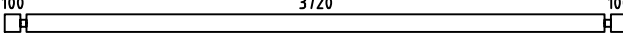
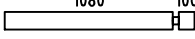

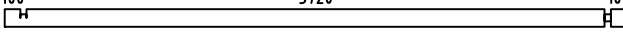
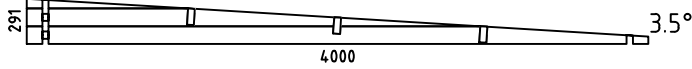
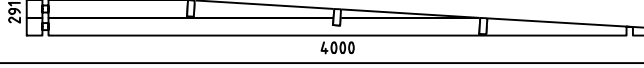
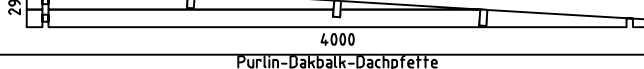
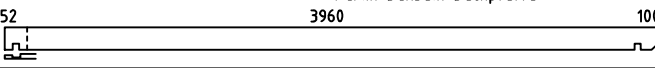
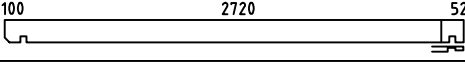

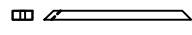
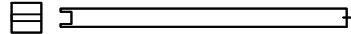
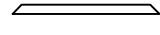
Model	Anton40	Page	3
Client		Scale	1:30
Material	4x11.4	Date	10.11.2016
Company		File	Anton40.dwg



Model	Anton40	Page	4
Client		Scale	1:30
Material	4x11.4	Date	10.11.2016
Company		File	Anton40.dwg

Pos	Specification-Spezifikation-Specificatie	St.	Profile (mm)	Length (mm)
001		2	40x57	690
002		33	40x114	690
003		16	40x114	3000
004		16	40x114	3950
005		2	40x114	3000
006		2	40x114	3950
007		1	40x57	3000
008		1	40x57	3950
009		27	40x114	4000
013		10	40x114	1220
014		15	40x114	315
015		1	40x114	4000
WA-1		1		
WB-1		1		
WC-1		1		
PR2		3	44x14.4	4192
PR1		3	44x14.4	2952
DP1	Roof board-Dachbrett-Dakplank 	80	88x18	4250
PD2	-Diagonal for POST 44x85 	1		500
	-POST 85x85 	1		1755
PD1	Diagonal for POST 44x85 	1		500
L2	Eave Board-Traufenblende-Afdeklank 	2	18x120	4290
L1	Facia Board-Giebelblende-Gevelplank 	4	18x120	3518
H1	H-Profile 	1		228
H2	H-Profile 	1		1835
Kood	Materjal	File	Anton40.dwg	Leht 1/2

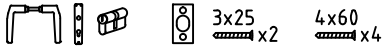
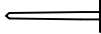
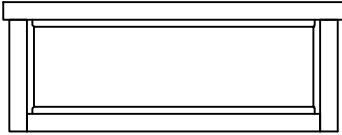

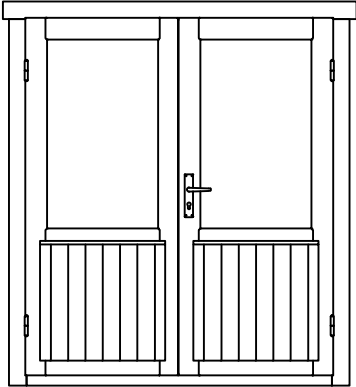
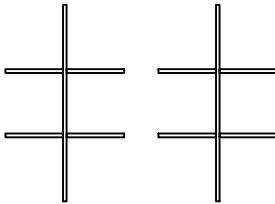
Pos	Specification-Spezifikation-Specificatie	St.	Profile (mm)	Length (mm)
	Adjustable foot-Stellfuß+Schrauben 4x50 4stück für Post 	1		
	Double Door Set-Doppeltür Satz-Dubbele Deur Set 	1		
	Nail-Nagel-Spijker 1.2x20 	25		
W0 1 54X54	WINDOW 1540x540  <p>             Window Glazing Bar              Fenstersprossen              Raamroeden           </p> 	1		
DD6 1 60X185	DOOR 1600x1850  <p>             Door Glazing Bar              Türsprossen              Deurroeden           </p> 	1		
Kood	Materjal	File	Anton40.dwg	Leht 2/2

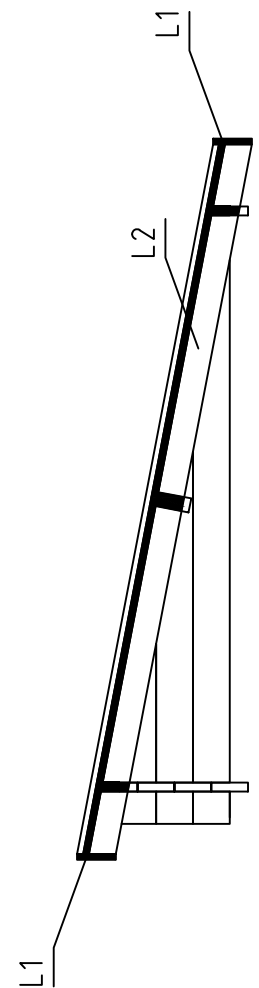
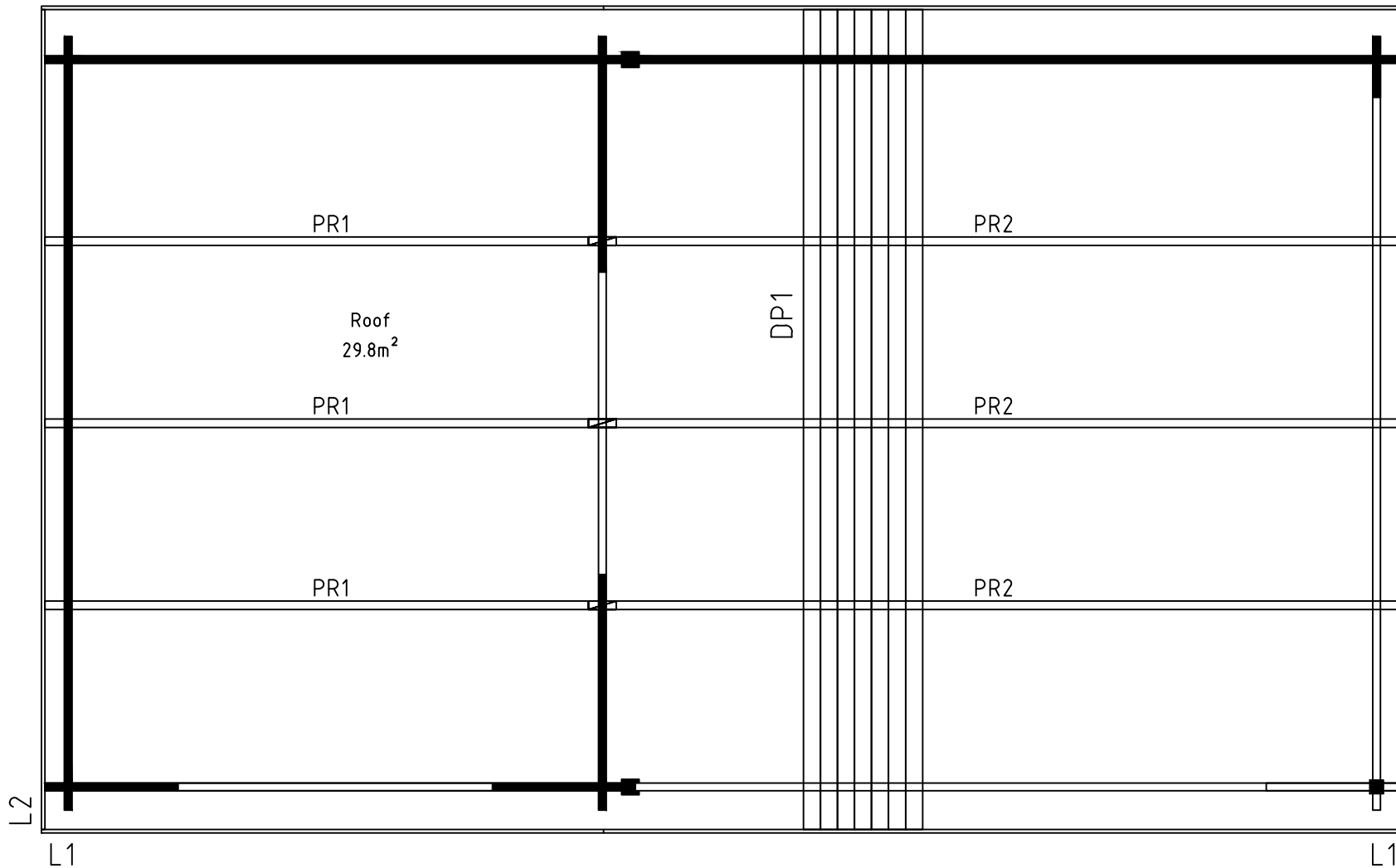

Model	Anton40	Page	
Client		Scale	1:30
Material	4x11.4mm	Date	10.11.2016
Company		File	Anton40.dwg

The guide is illustrative. This guide is not project specification.  
 Der Leitfaden ist illustrativ. Dieser Leitfaden ist keine Projektspezifikation.  
 De gids is illustratief. Deze gids is geen projectspecificatie.

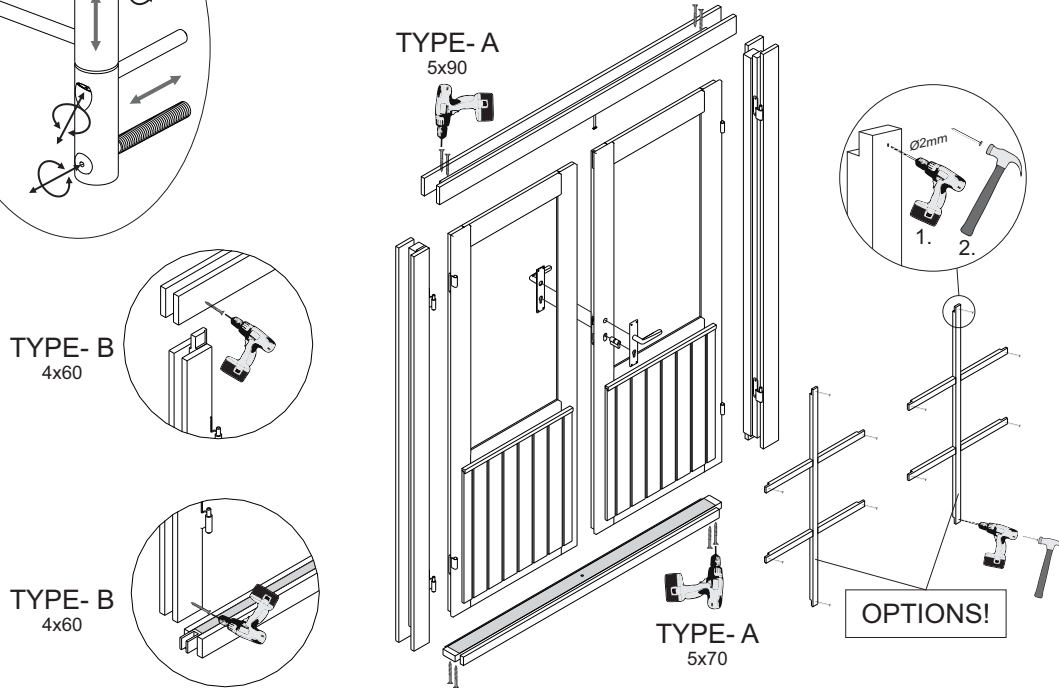
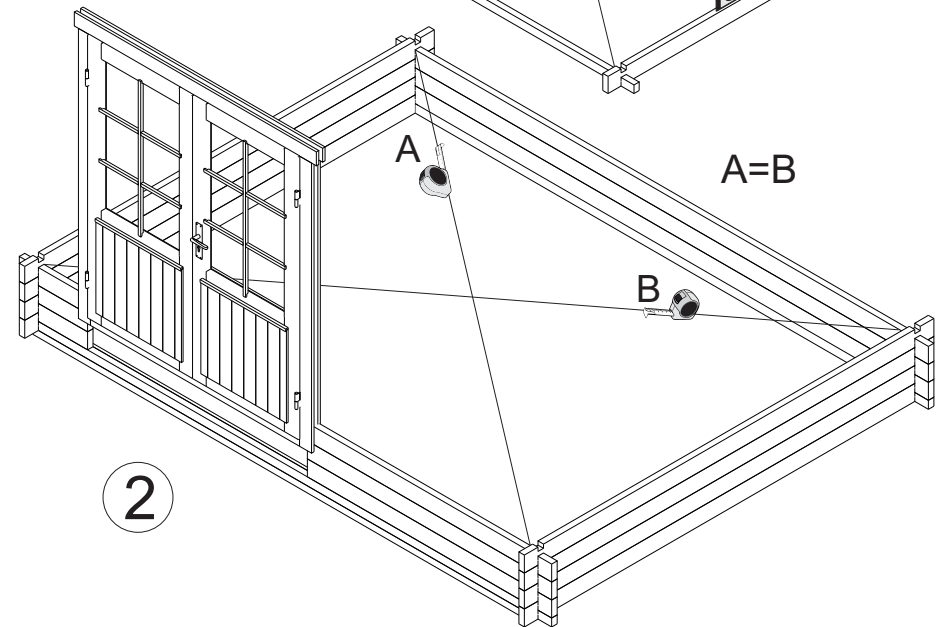
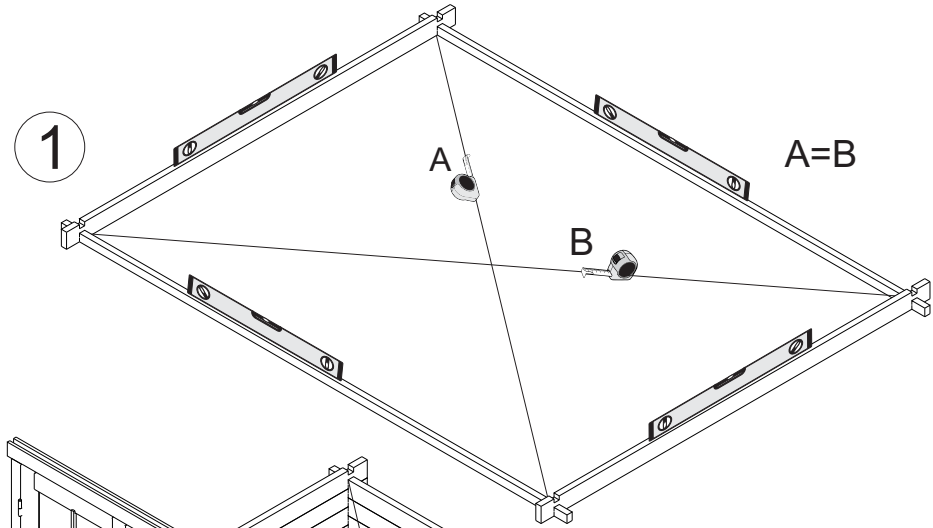
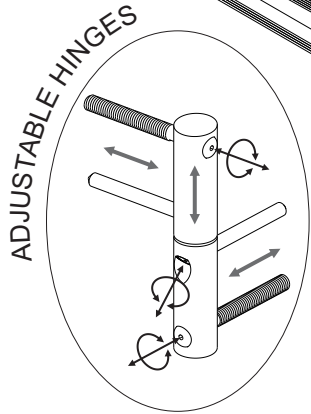
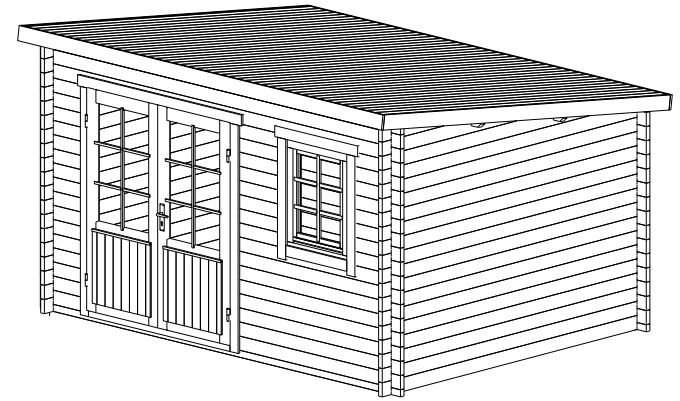
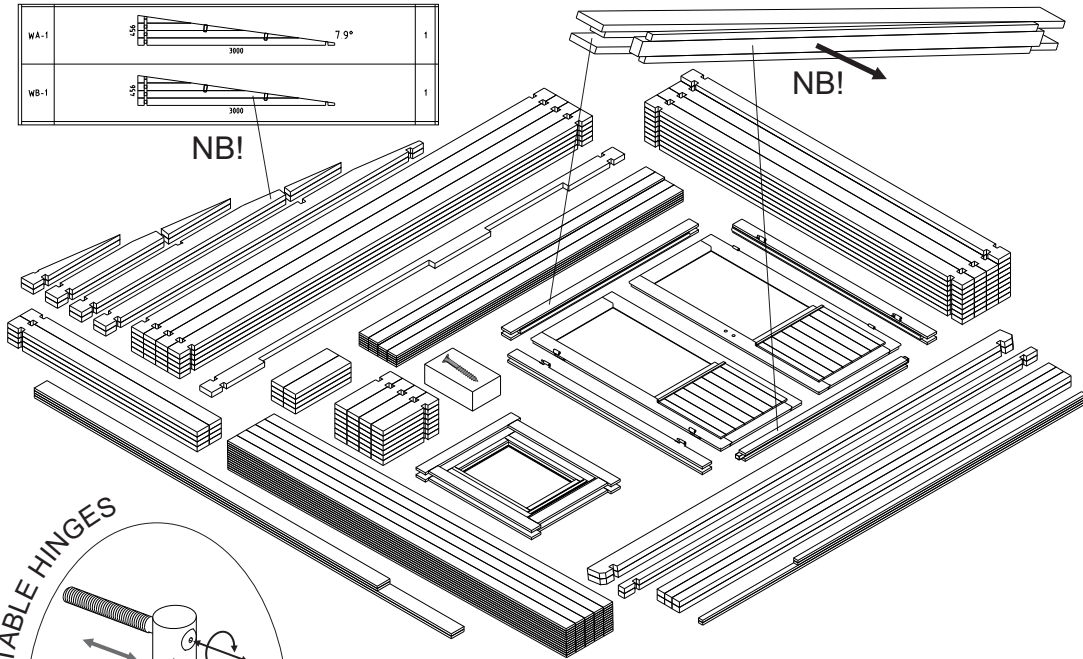
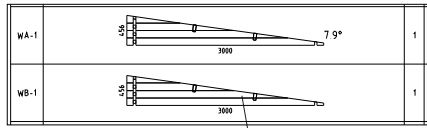

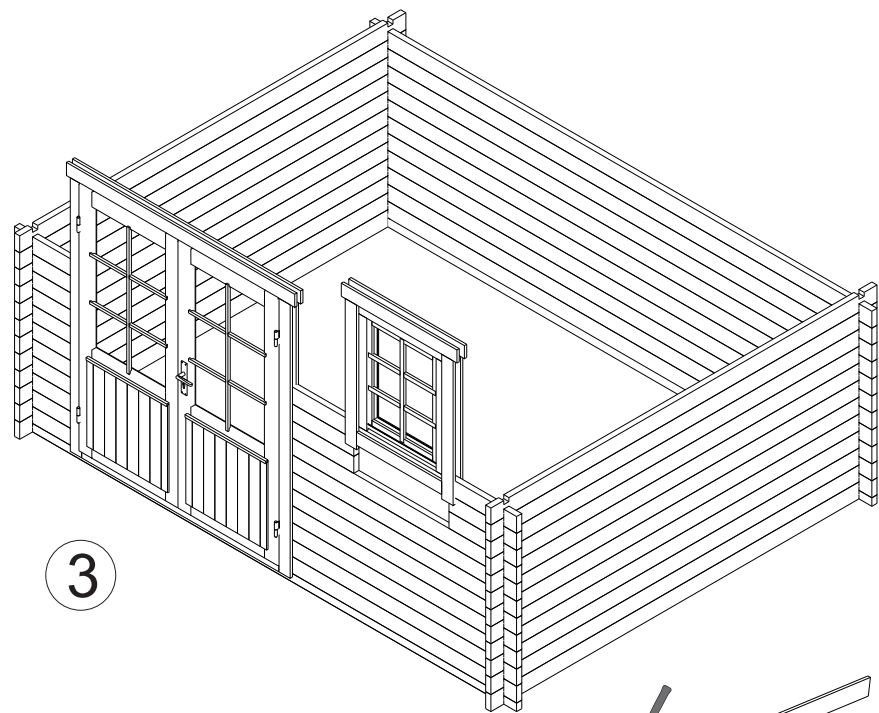

4

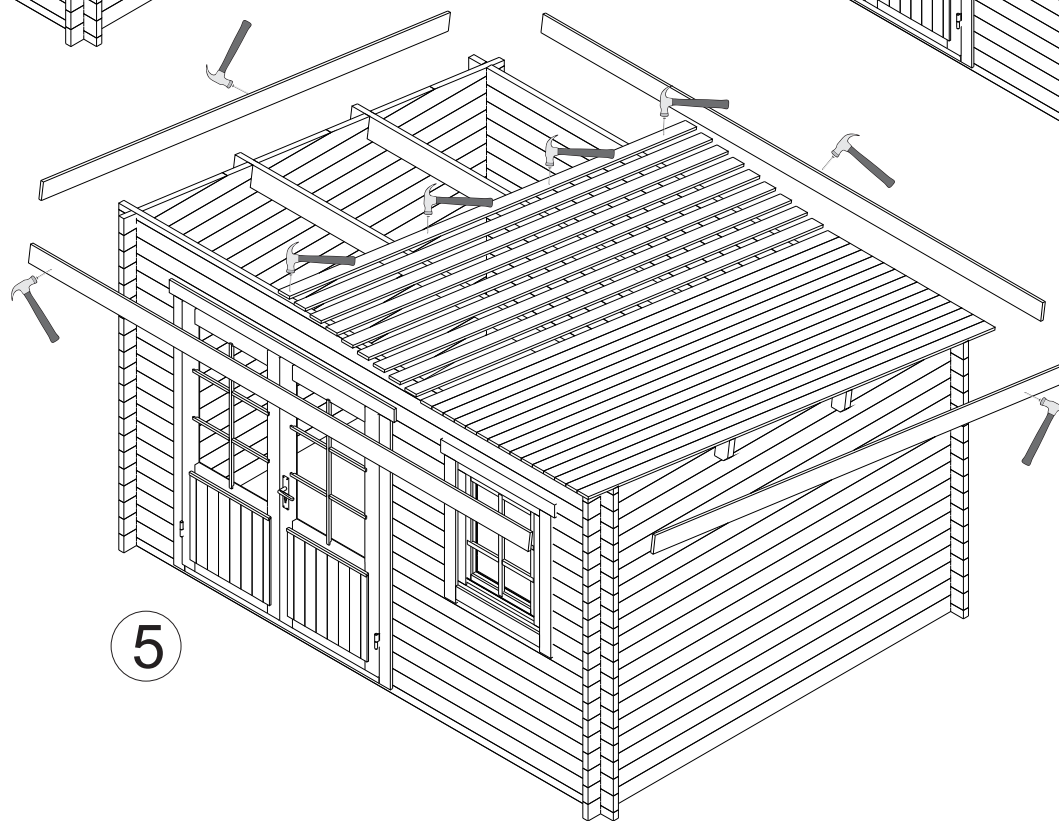
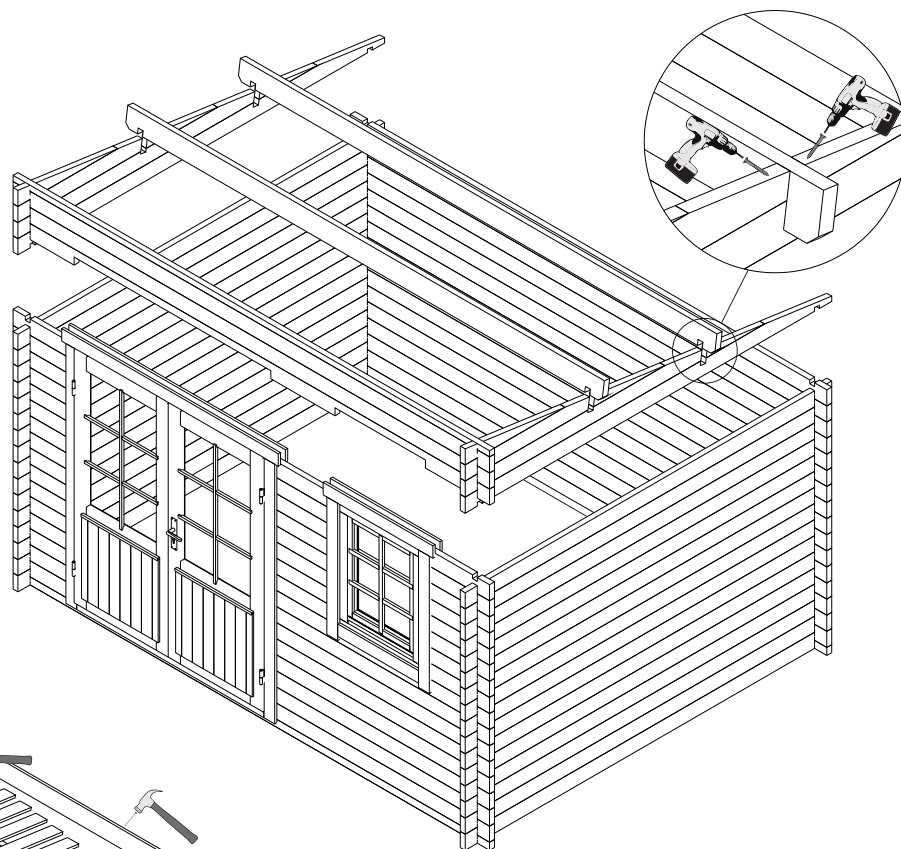

# POST

