

3.1

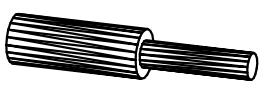

4

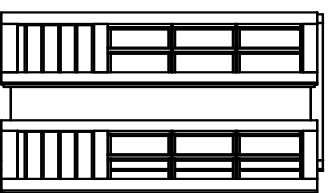

5

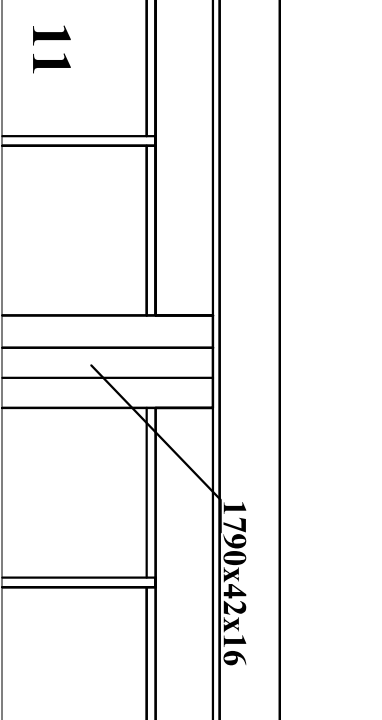
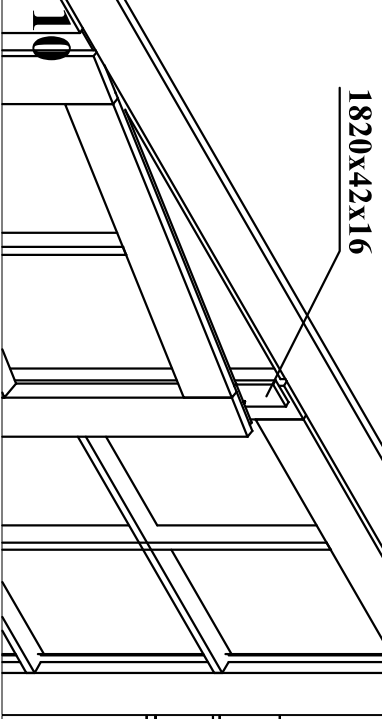
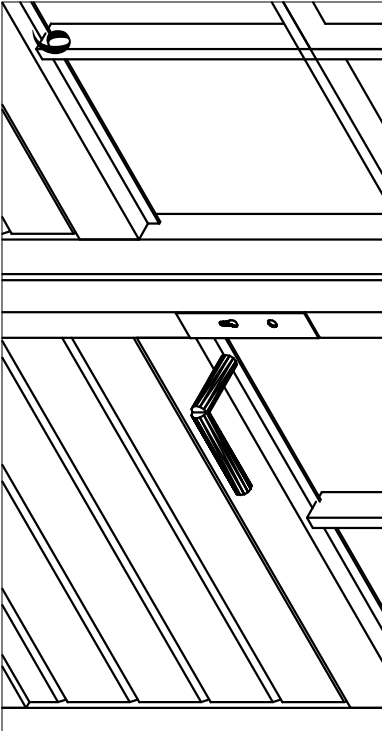
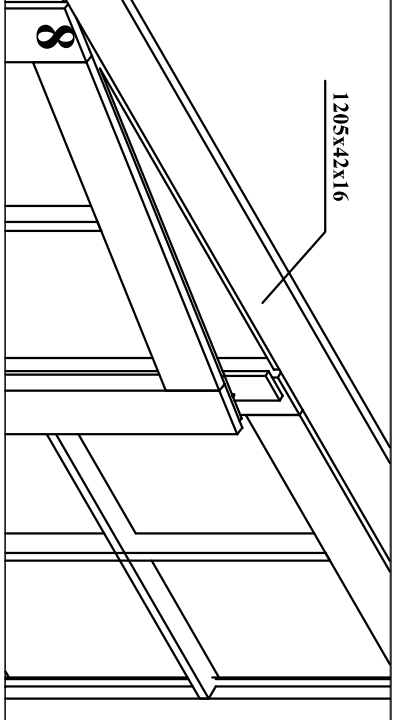
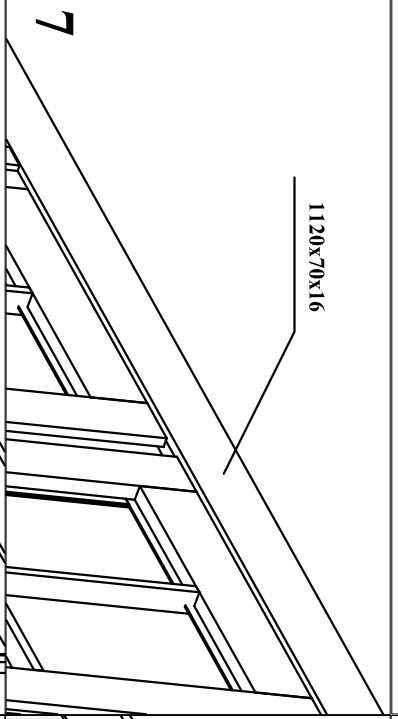
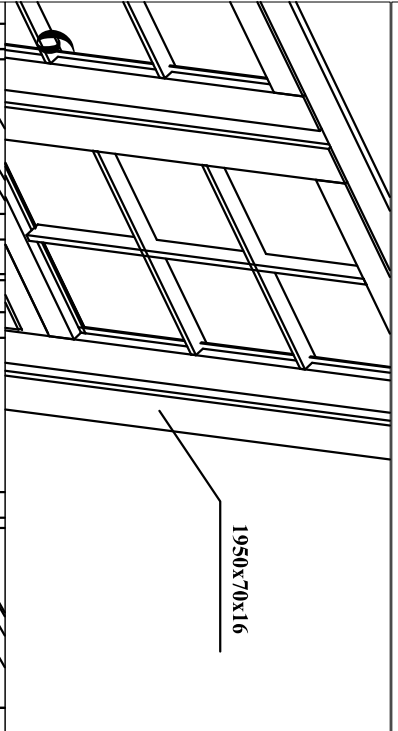
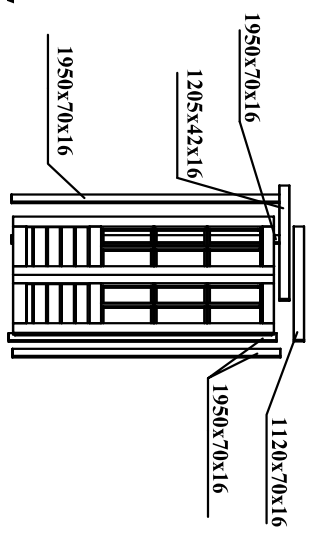

BUILDING CODE **CHRISTOFFER**

WALL LOG (mm): 28

SIZE (mm): 5750x3500

ISOMETRIC ROOF'S CONSTRUCTION

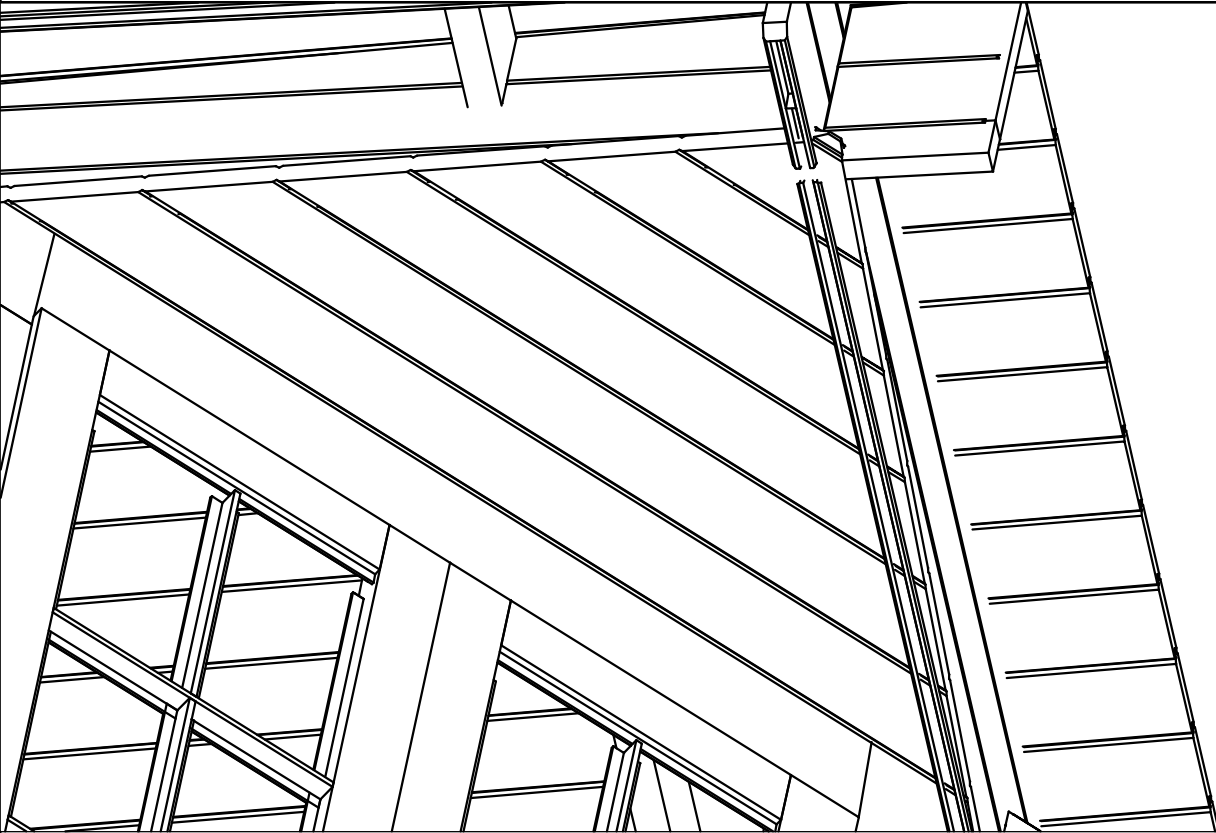

PACKAGE NR.:

MNFCT. ORDER NR.:

CONTROL 1

CONTROL 2

SIGNATURE

SIGNATURE

PAGE/PAGES: **7/7**

BUILDING CODE **CHRISTOFFER**

WALL LOG (mm): 28

SIZE (mm): 5750x3500

CONSTRUCCION 3

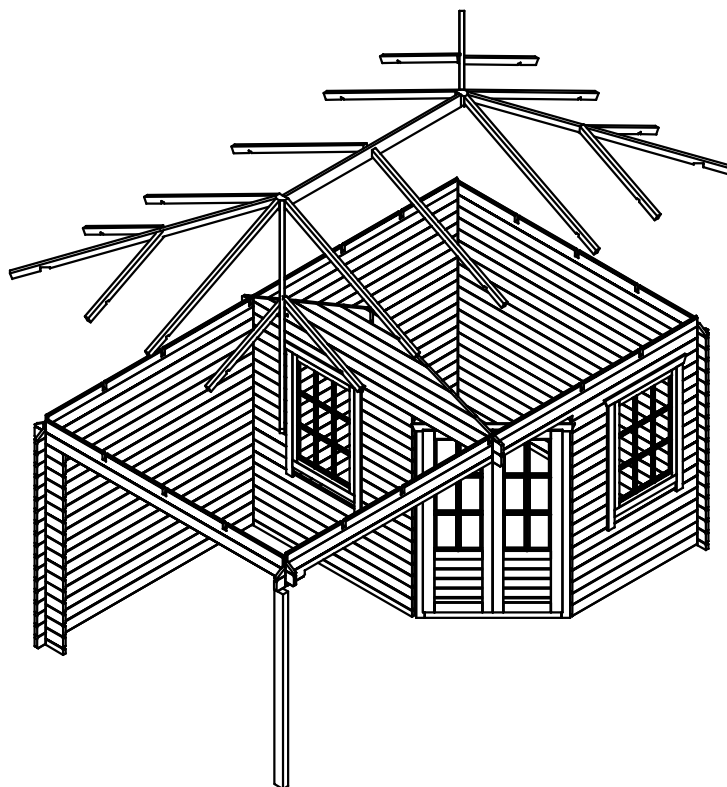

CONSTRUCCION 4

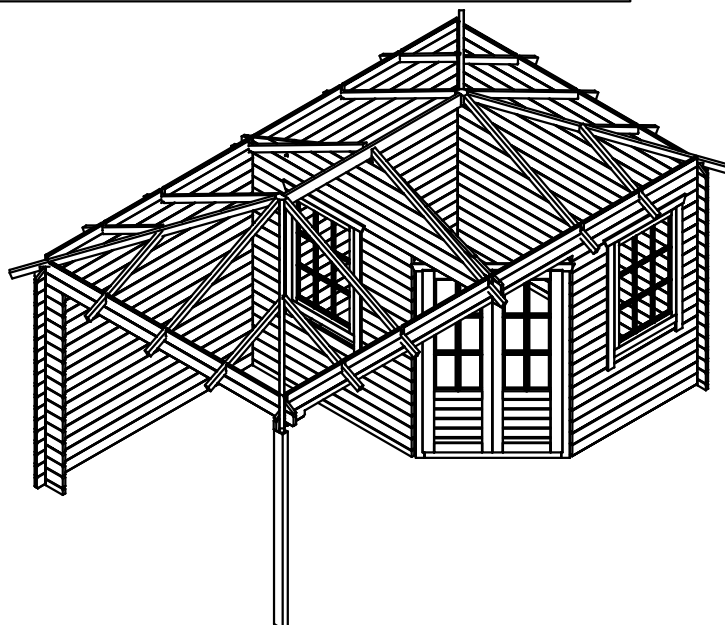

PACKAGE NR.:

MNFCT. ORDER NR.:

CONTROL 1

SIGNATURE

CONTROL 2

SIGNATURE

PAGE/PAGES:

6/7

BUILDING CODE **CHRISTOFFER**

WALL LOG (mm): 28

SIZE (mm): 5750x3500

CONSTRUCCION 1

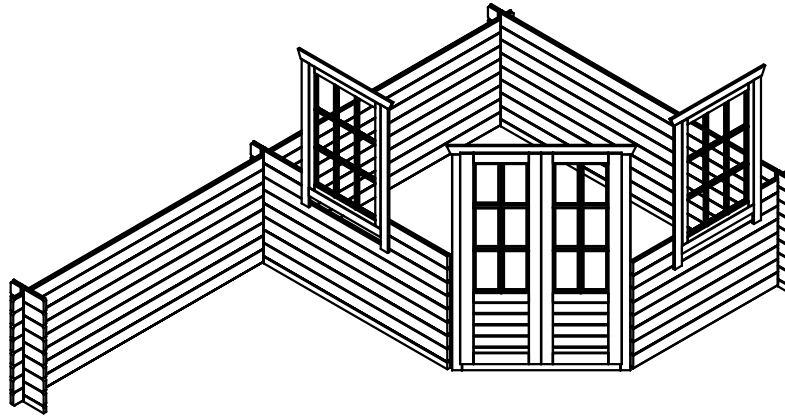

CONSTRUCCION 2

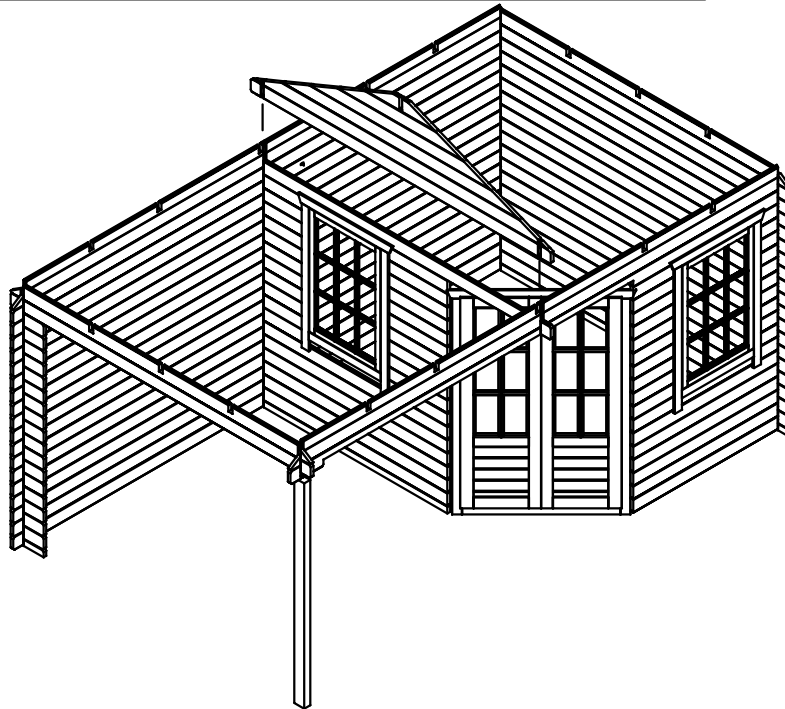

PACKAGE NR.:

MNFCT. ORDER NR.:

CONTROL 1

CONTROL 2

SIGNATURE

SIGNATURE

PAGE/PAGES: **5/7**

BUILDING CODE **CHRISTOFFER**

WALL LOG (mm): 28

SIZE (mm): 5750x3500

LEFT VIEW

Ⓒ

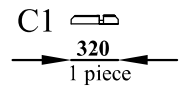
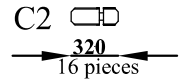
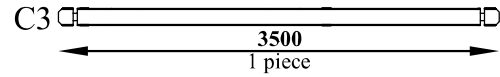
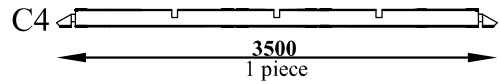
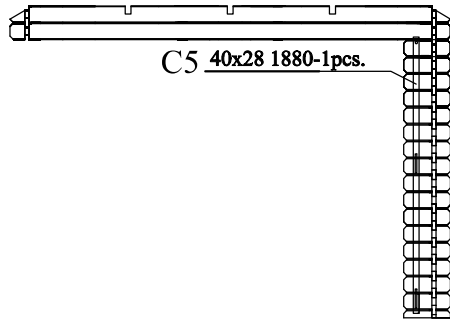

MIDDLE VIEW

Ⓓ

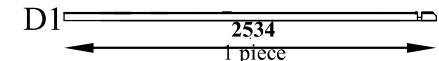
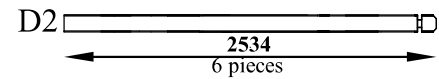
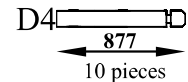
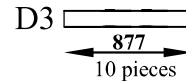
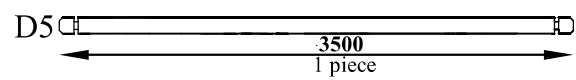
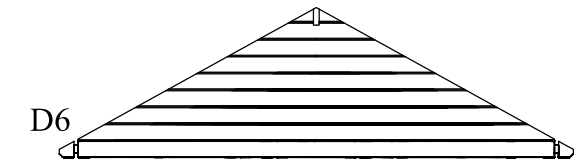
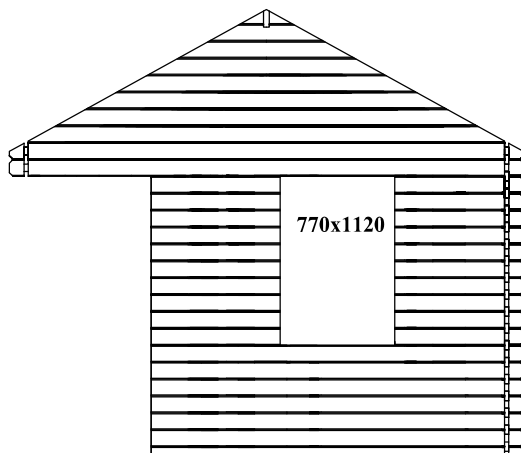

RIGHT VIEW

Ⓔ

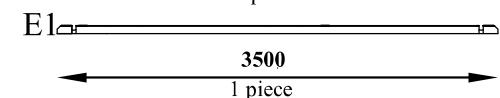
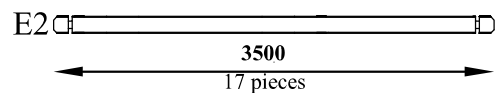
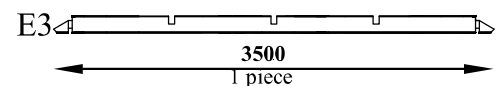
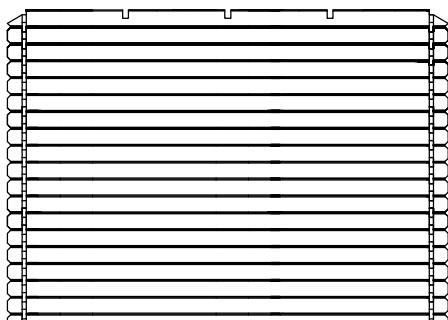

PACKAGE NR.:

MNFCT. ORDER NR.:

CONTROL 1

CONTROL 2

SIGNATURE

SIGNATURE

PAGE/PAGES:

4/7

BUILDING CODE **CHRISTOFFER**

WALL LOG (mm): 28

SIZE (mm): 5750x3500

FRONT VIEW

(A)

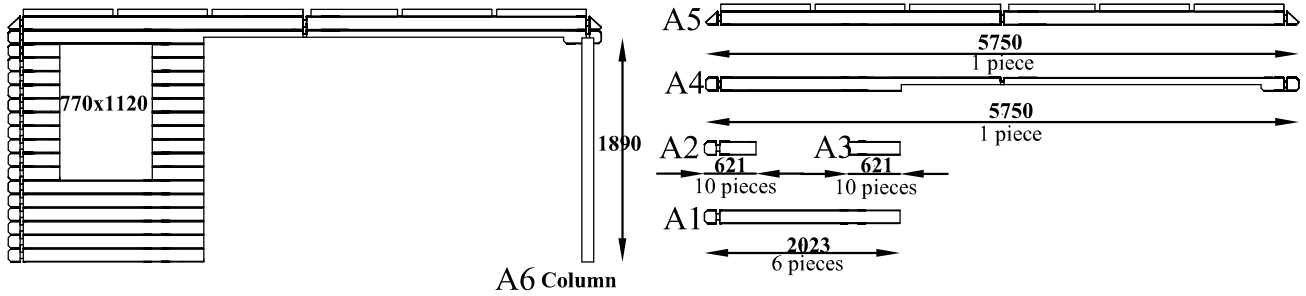

BACK VIEW

(B)

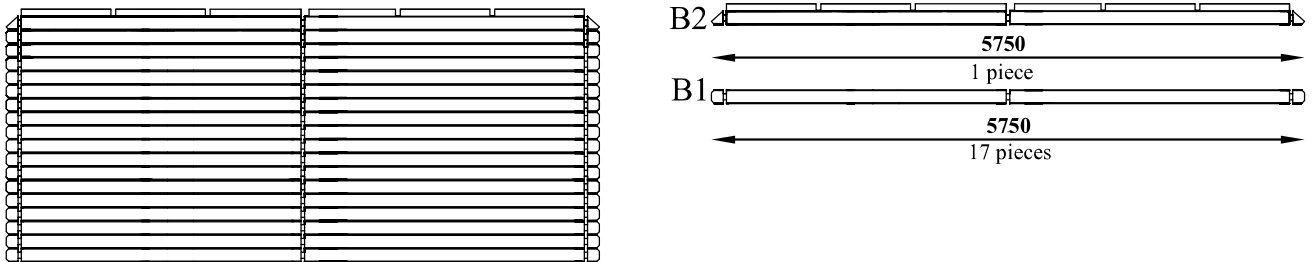

PACKAGE NR.:

MNFCT. ORDER NR.:

CONTROL 1

CONTROL 2

SIGNATURE

SIGNATURE

PAGE/PAGES: **3/7**

BUILDING CODE **CHRISTOFFER**

WALL LOG (mm): 28

SIZE (mm): 5750x3500

ISOMETRIC VIEW

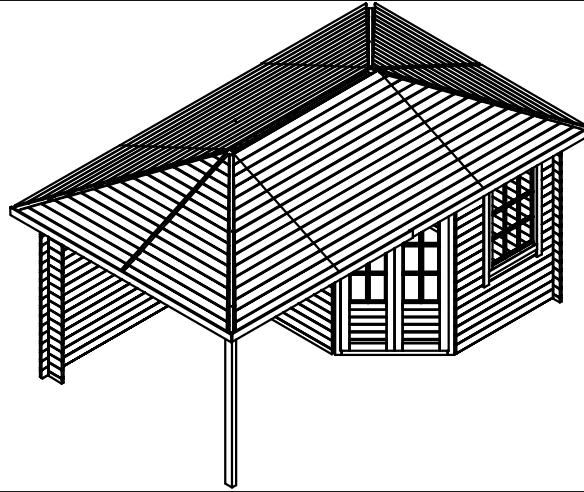
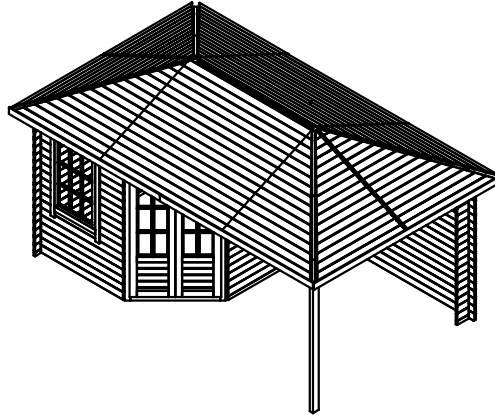

TOP VIEW

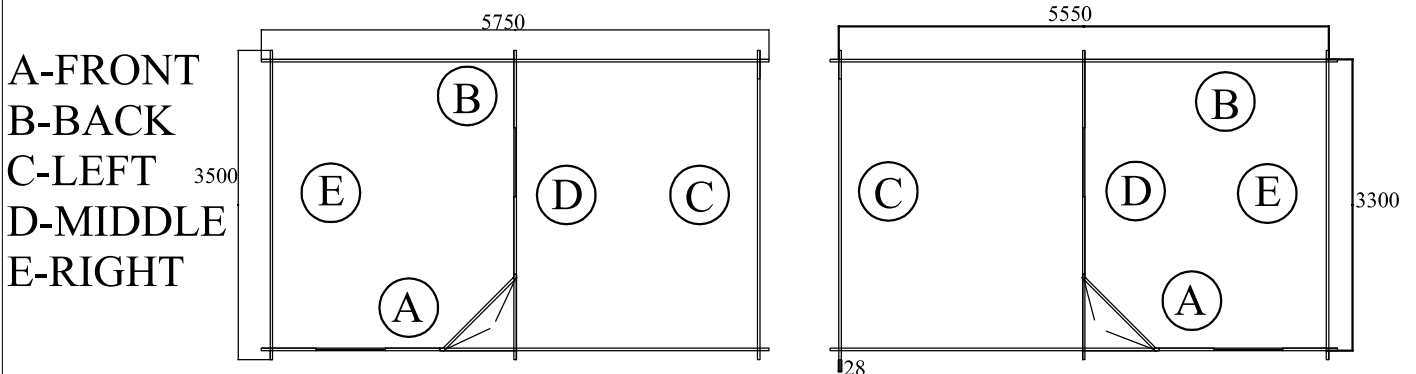

PACKAGE NR.:

MNFCT. ORDER NR.:

CONTROL 1

CONTROL 2

SIGNATURE

SIGNATURE

PAGE/PAGES: **2/7**

Always keep the package number saved! Without package number their is no guarantee.:

Package number:

WALL LOG (mm): 28

BUILDING CODE **CHRISTOFFER**

SIZE (mm): 5750x3500

COMPONENT SPECIFICATION

NUMBER	COMPONENT FUNCTION	COMPONENT CODE	VIEW	SIDE VIEW	DIMENSIONS (mm)			QUANTITY (psc.)
					LENGHT	WIDTH	THICKNESS	
1	Wall board	A1			2023	115	28	6
2	Wall board	A2			621	115	28	10
3	Wall board	A3			621	115	28	10
4	Wall board	A4			5750	115	28	1
5	Wall board	A5, B2			5750	115	28	2
6	Wall board	B1			5750	115	28	17
7	Wall board	C2			320	115	28	16
8	Wall board	C3,D5,E2			3500	115	28	19
9	Wall board	C4, E3			3500	115	28	2
10	Wall board	D2			2534	115	28	6
11	Wall board	D3			877	115	28	10
12	Wall board	D4			877	115	28	10
13	Wall board							
14	Wall board							
15	Wall board							
16	Wall board							
17	Wall board							
18	Wall board	E1			3500	60	28	1
19	Wall board	D1			2534	60	28	1
20	Wall board	C1			320	60	28	1
21	Apex	D6			3500		28	1
22	Bracer	C5			1880	40	28	1
23	Door	D-4			1200	1880	28	1
24	Window	W-1			770	1120	28	2
25	Column	A6			1890	100	60	1
26	Roof cover fixture				3800/3100	100	16	2/4
27	Roof board				2250	110	19	42/8
28	Beam				2737/2113/ 2071/1175	60	40	4/2/6/8
29	Beam with octagon				2210	120	40	1
30								

PACKAGE NR.:

MNFCT. ORDER NR.:

CONTROL 1

CONTROL 2

PAGE/PAGES:

1/7

SIGNATURE

SIGNATURE