





















Pos	COVENTRY 4,4 x 3,4 + 2,0 + 1,5 58x135	Profile	Length	St.
D2 C2		58x135	5870	2
G2		58x58	3640	1
B2		58x135	5900	12
E6			4400	1
D3 C3 G1			3400	27
C4			3400	1
D1 C1			5630	8
C6			637	14
E2			1050	4
E5			1050	2
A3			820	12
A2			560	26
C9 D7 E4		400	8	
C5 D4 E3		258	44	
B1 A1		58 x 67	5900	2
E1			1050	2
B3	APEX 	58x405	5900	1
A4	APEX 	58x540	4531	1
B4	APEX 		4531	1
E7	APEX 		4400	1
A5				5114
A6		58x135	1857	1
A7			2060	1
28	ROOFING BOARDS	19 x 85	2380	97
29			3960	43
30	WINDOW	2126 x 966	1	1
31	Block of doors	3280 x 1938	1	1
32	Door	680 x 1610	1	1
33	Roof of cover fixture	20x120 or 20x145	4010	1
			1590	1
			2430	3
35	Roof of cover fixture	20x95	4030	1
			1610	1
			2450	3
			2935	2
44	Beam	40x40	3640	1
			2230	1
45	Roof Joist	58x145	3520	4
46			2608	4
45V1	Ridge Beam		3391	1
46V1			2479	1
47			1972	2
47V1	Amrest	28x95	830	2
47V2			677	2
48	Diamond			2
E8	Beam	40x40	2160	2



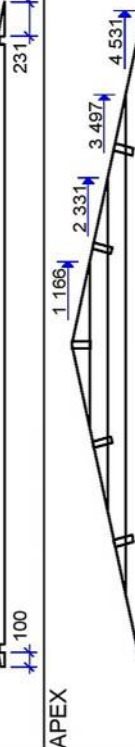
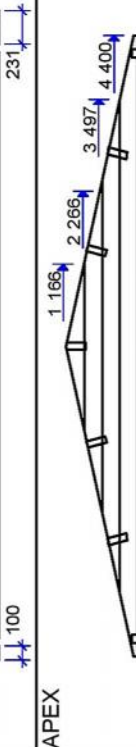
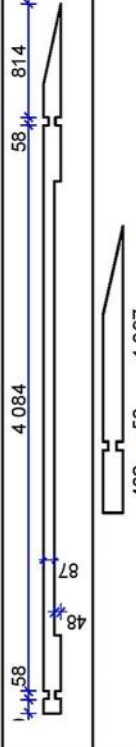

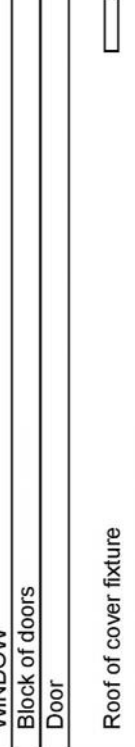
**COVENTRY 4,4 x 3,4 + 2,0 + 1,5 58\135 mm**

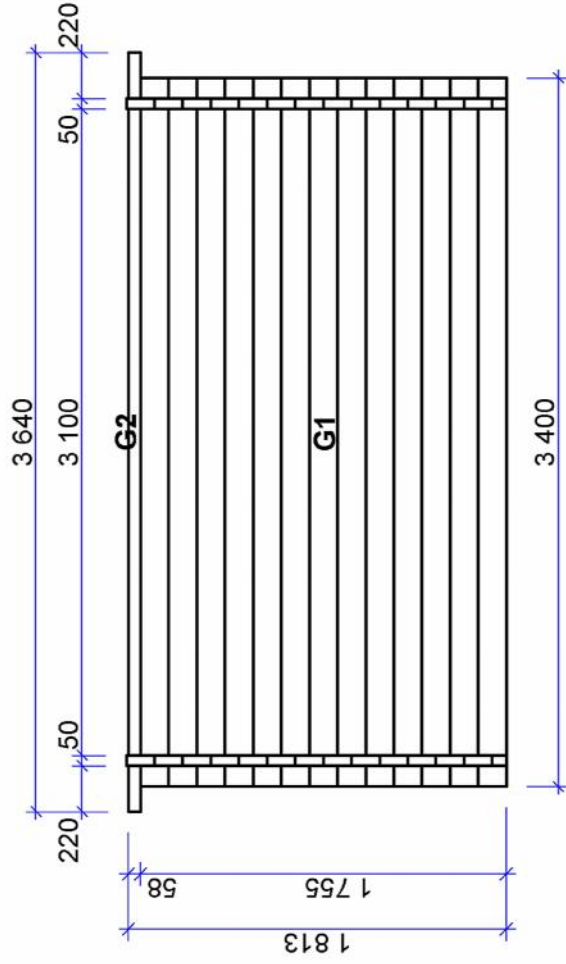
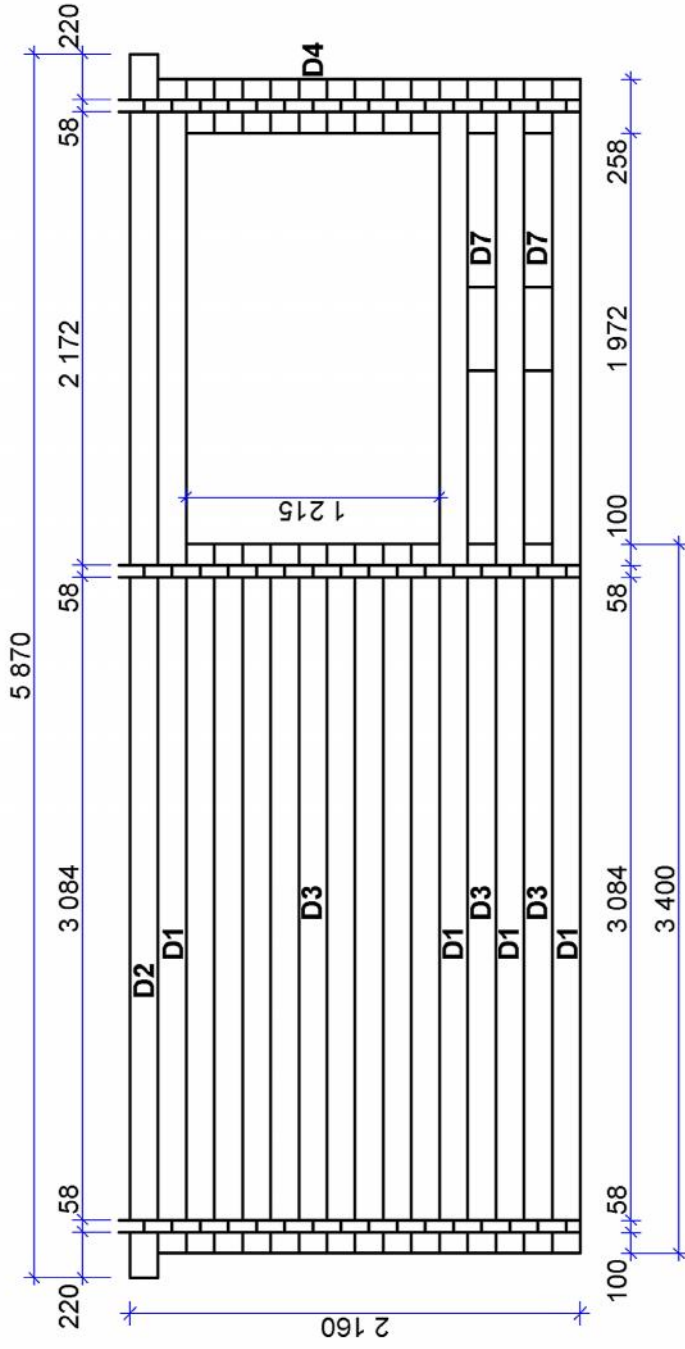
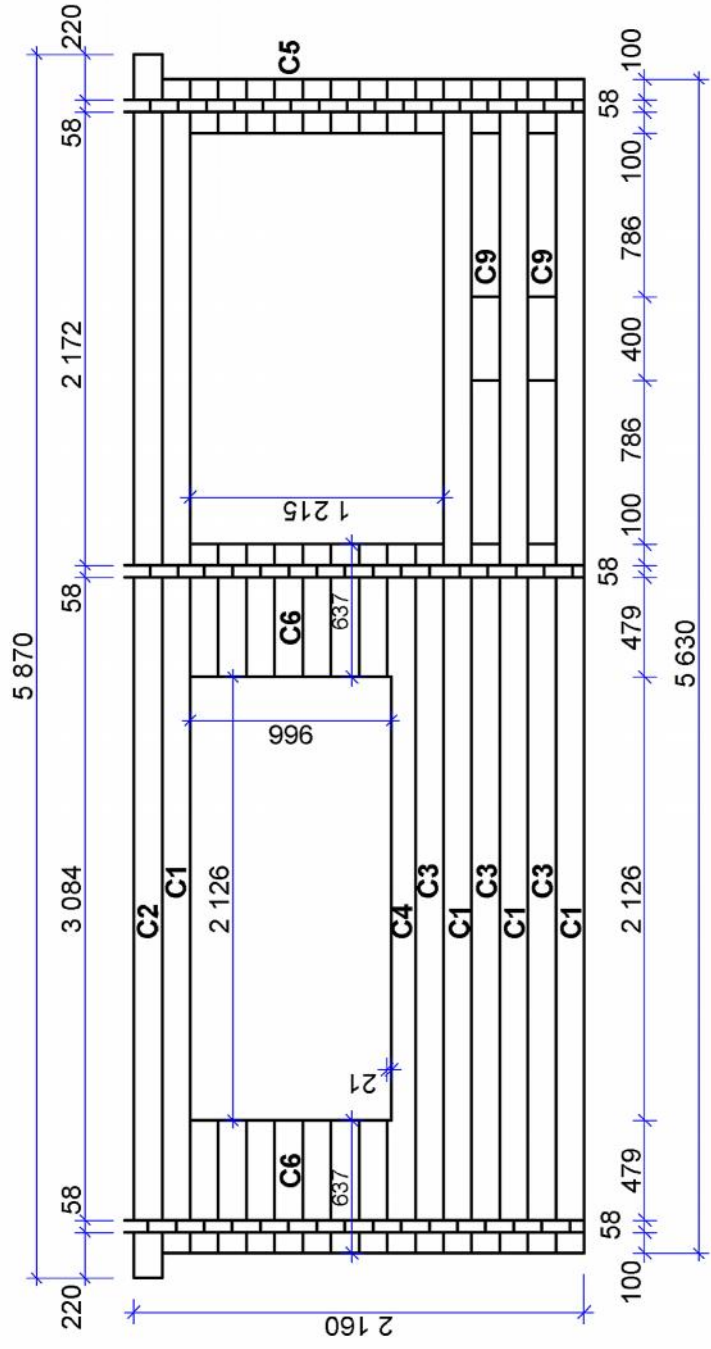
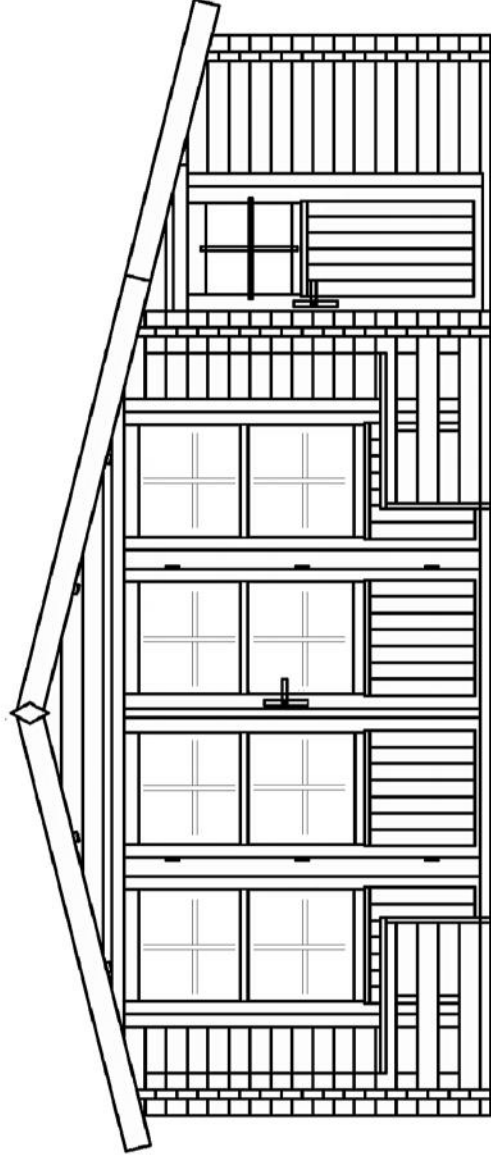
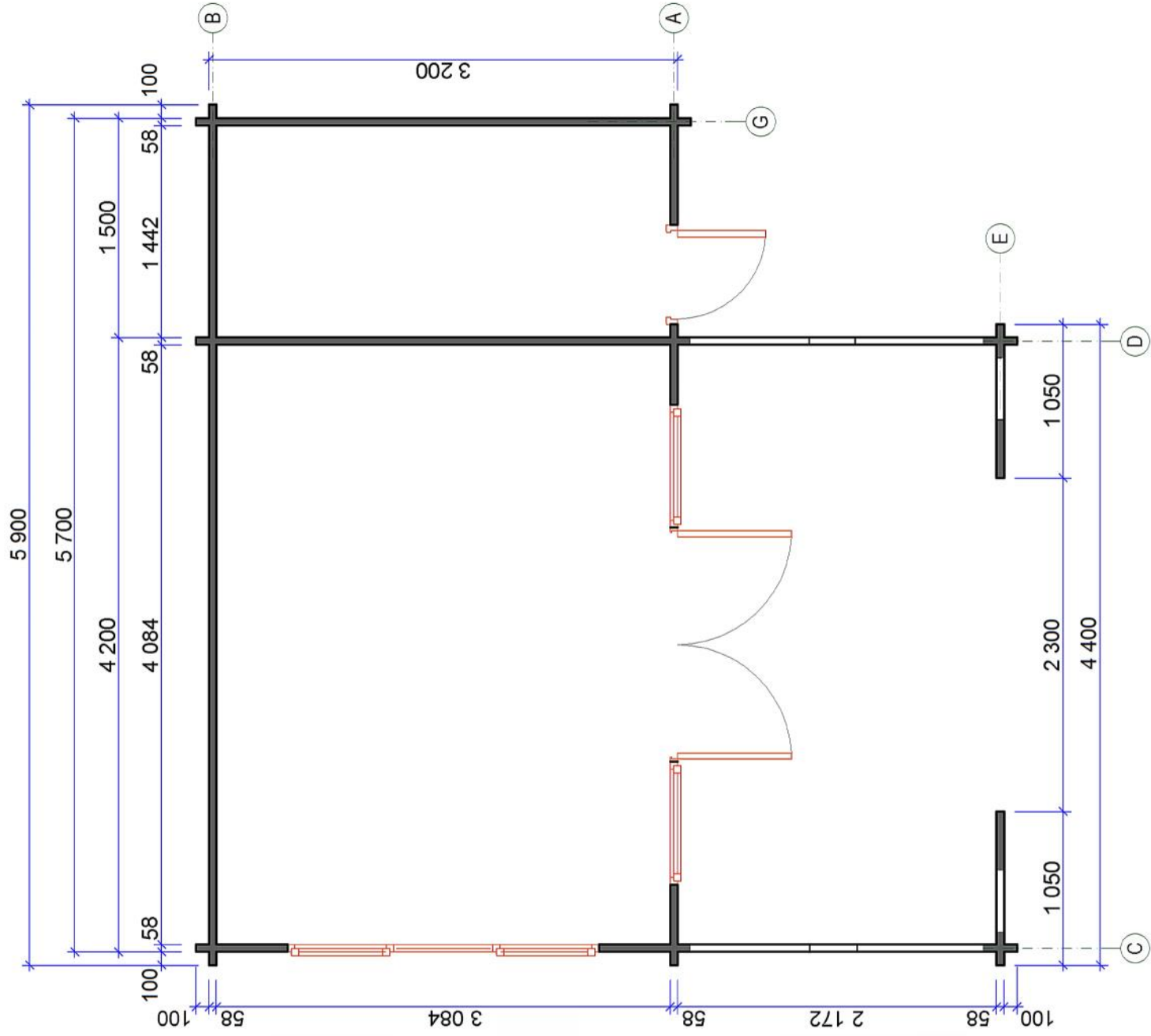
Wall B

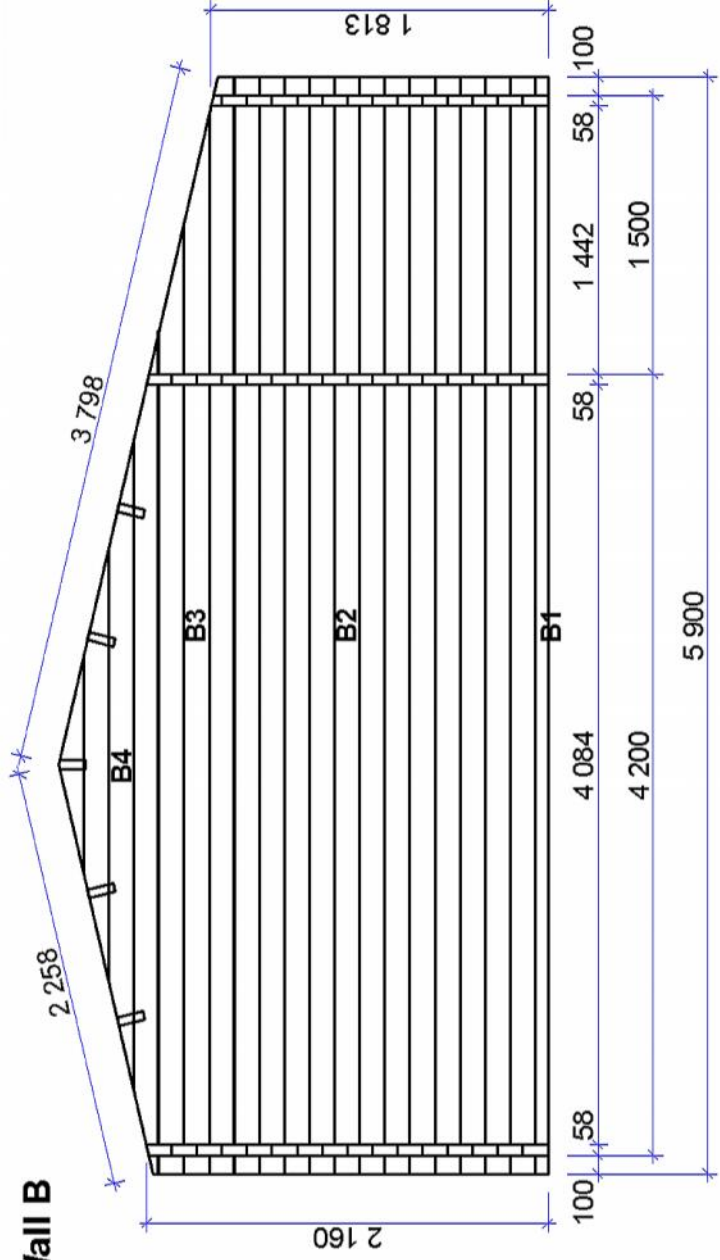

Wall A

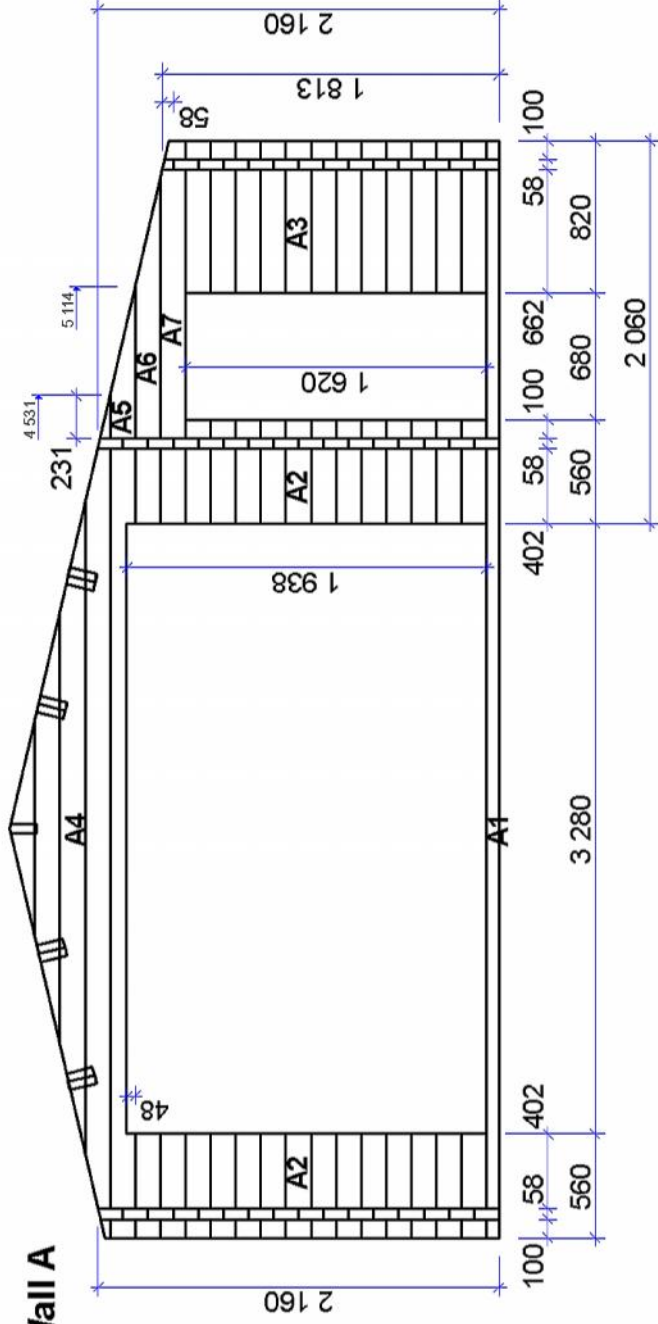

Wall E

