

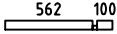

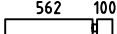



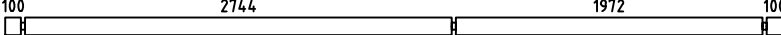
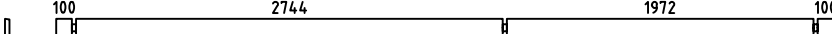
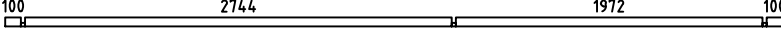
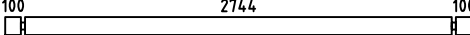
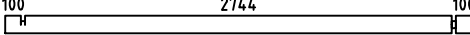
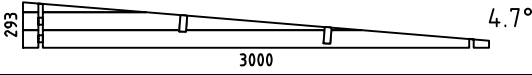
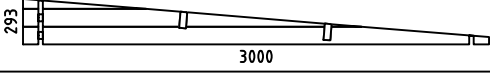
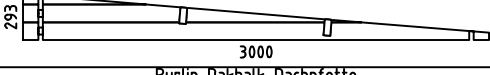
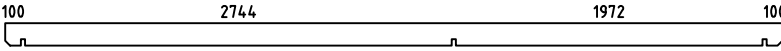

Dora28

Pos	Specification-Spezifikation-Specificatie	St.	Profile (mm)	Length (mm)
001		2	28x57	690
002		32	28x114	690
003		16	28x114	315
004		16	28x114	5000
005		2	28x114	5000
006		1	28x57	5000
007		32	28x114	3000
011		1	28x114	3000
WA-1		1		
WB-1		1		
WC-1		1		
PR1		2	44x144	5000
DP1	Roof board-Dachbrett-Dakplank 	57	88x18	3250
	-POST 85x85 	1		2005
L1	Eave Board-Traufenblende-Afdekplank 	2	18x120	5036
L2	Facia Board-Giebelblende-Gevelplank 	2	18x120	3290
	Adjustable foot-Stellfuß+Schrauben 4x50 4stück für Post 	1		
	Double Door Set-Doppeltür Satz-Dubbele Deur Set 	1		
	Nail-Nagel-Spijker 1.2x20 	15		
DD6 1 60X185	DOOR 1600x1850 Door Glazing Bar Türsprossen Deurroeden 	1		
Kood	Materjal	File	Dora28.dwg	Leht 1/1

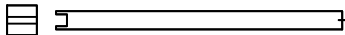
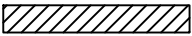

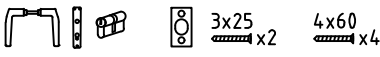
Model	Dora28	Page	PLAN
Client		Scale	1:30
Material	28x114,mm	Date	11.05.2017
Company		File	Dora28.dwg

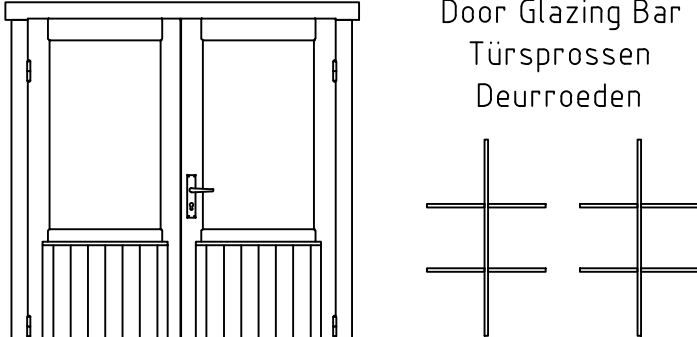
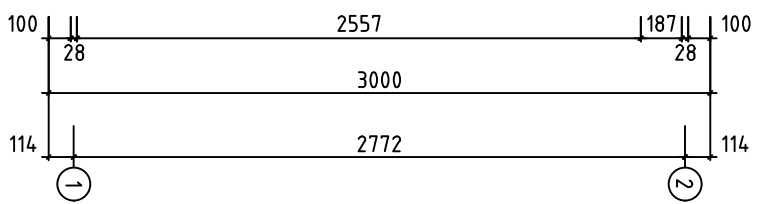
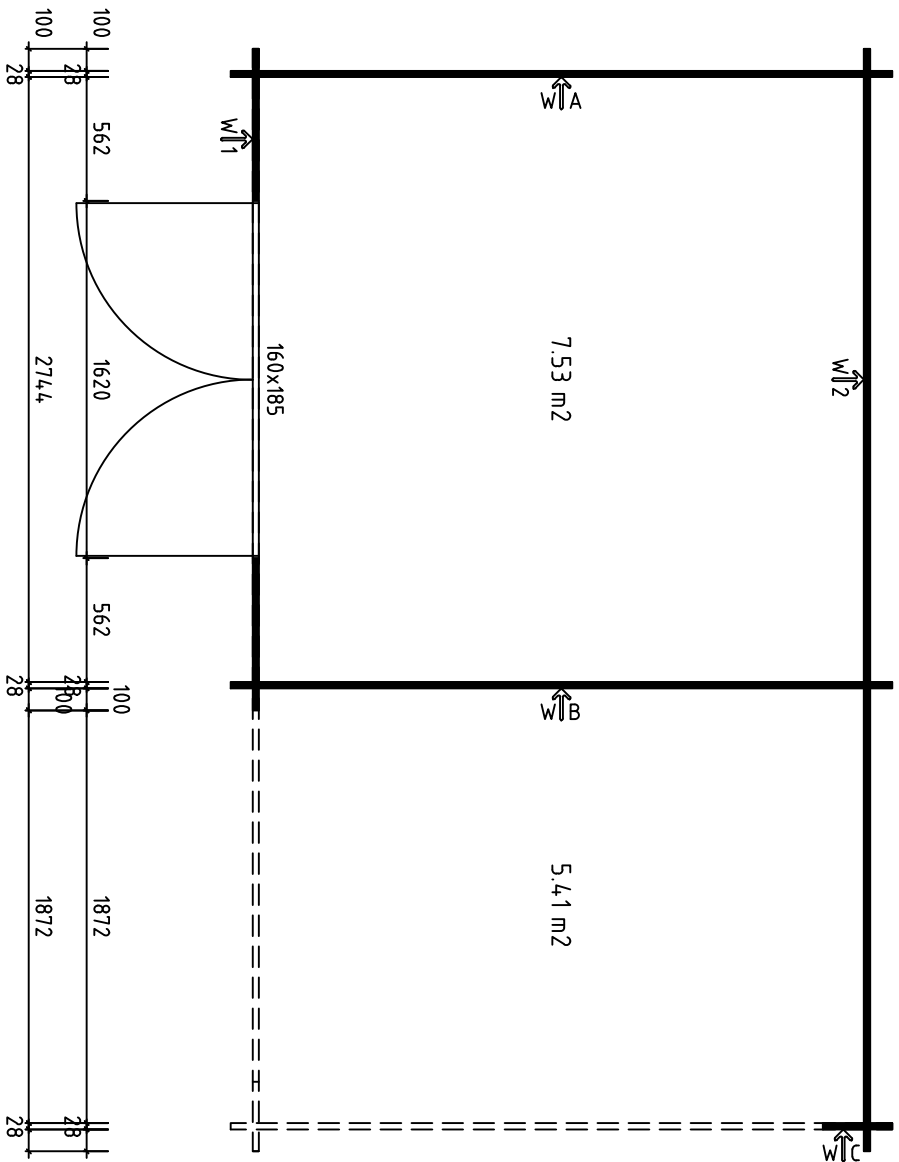
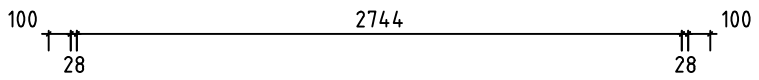
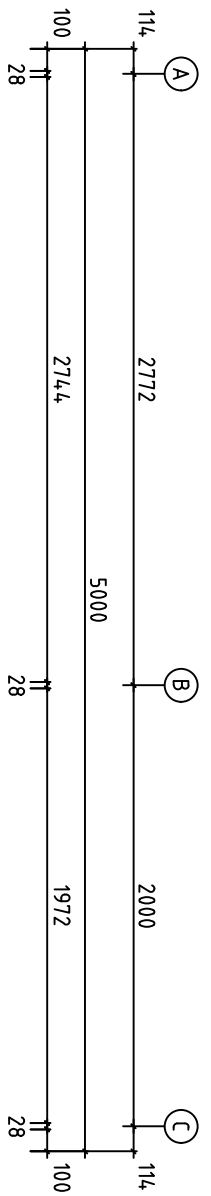
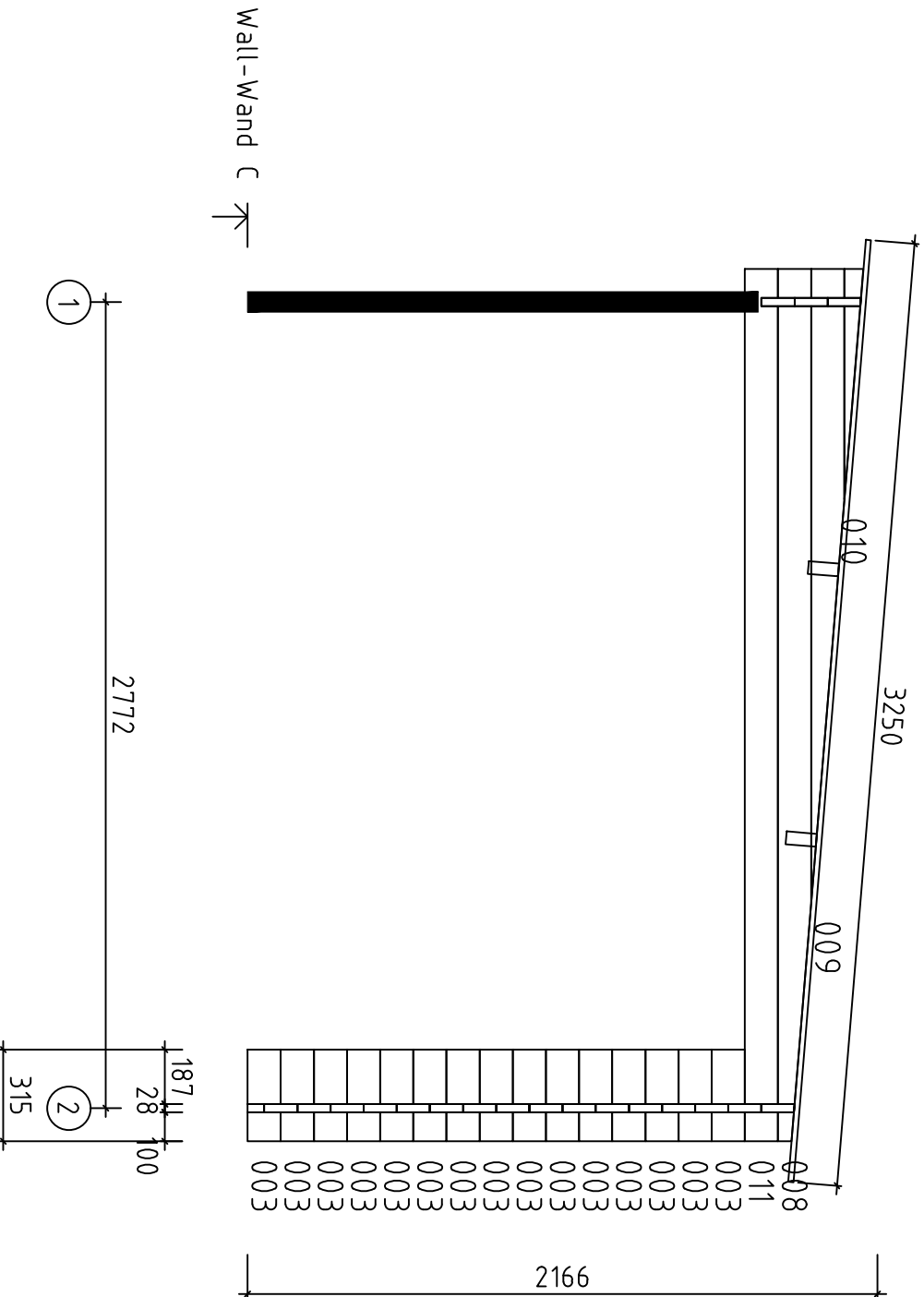

Model	Dor28	Page	4
Client		Scale	1:30
Material	2.8x11.4	Date	11.05.2017
Company		File	Dor28.dwg

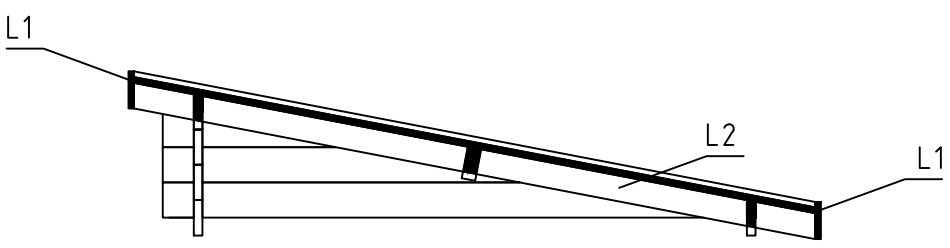
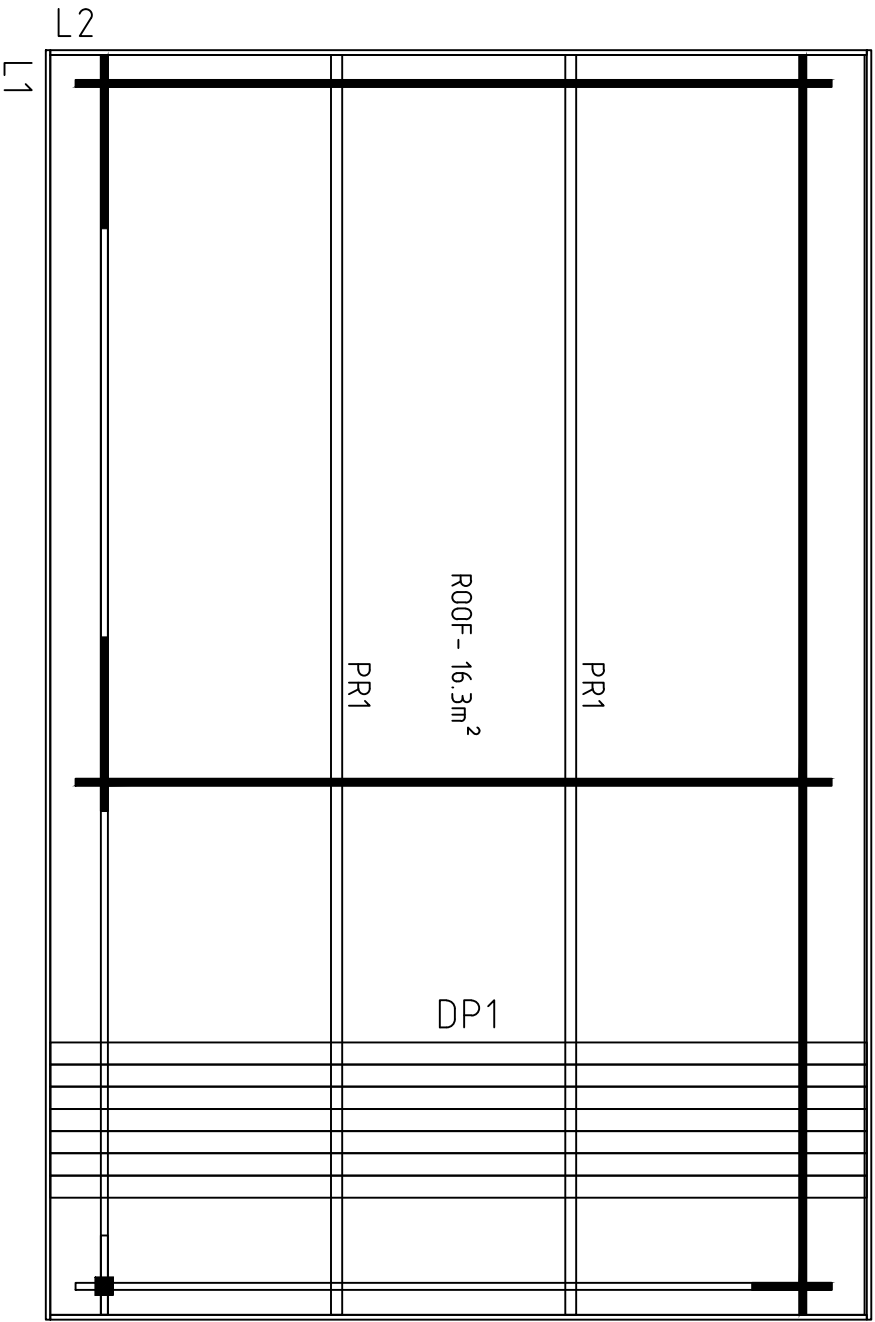

Model	Dora28	Page	
Client		Scale	1:30
Material	28x114mm	Date	11.05.2017
Company	File Dora28.dwg		

The guide is illustrative. This guide is not project specification.
 Der Leitfaden ist illustrativ. Dieser Leitfaden ist keine Projektspezifikation.
 De gids is illustratief. Deze gids is geen projectspecificatie.

MA-1	32	2000	1
MA-1	32	2000	1
MB-1	32	2000	1

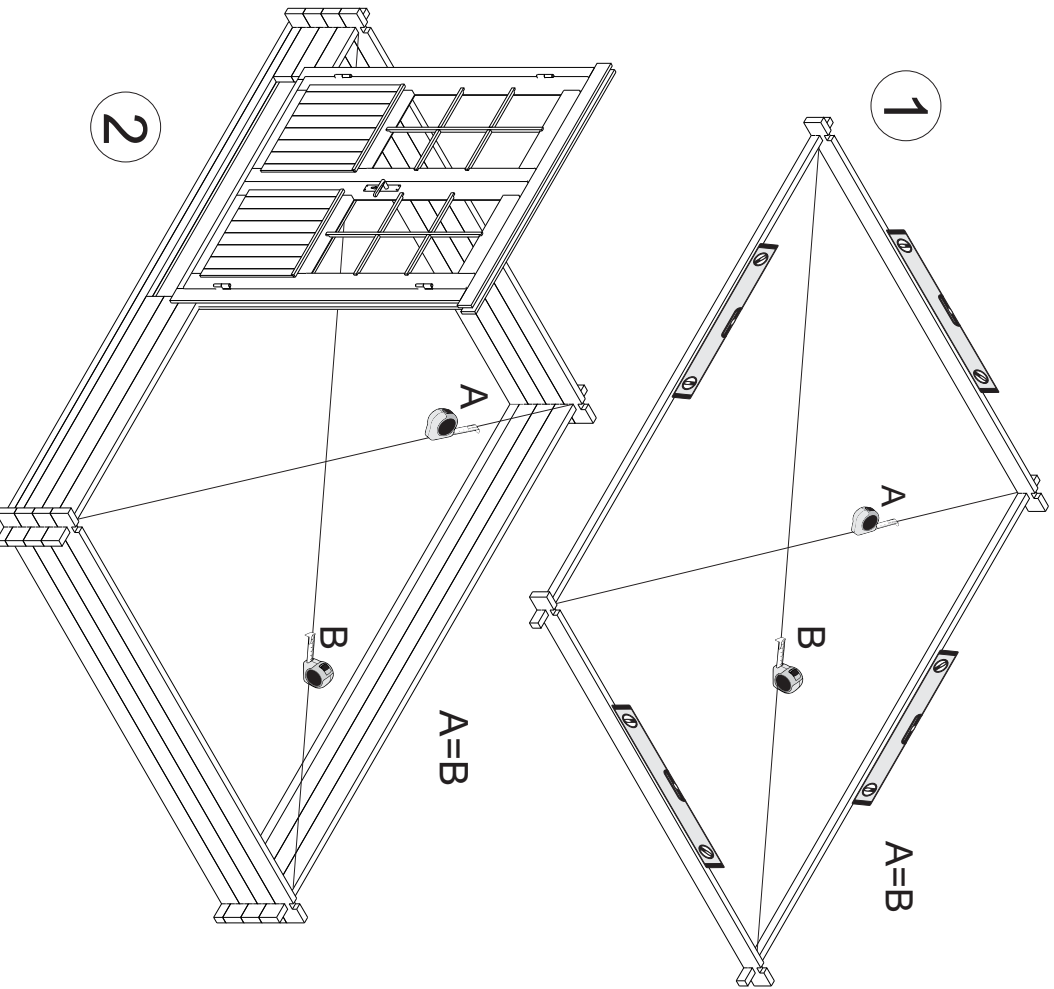
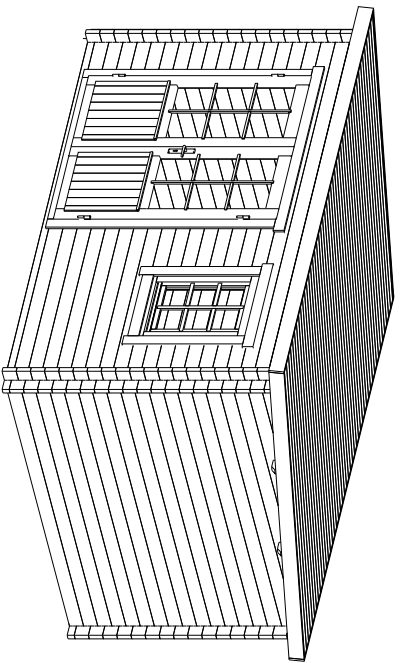
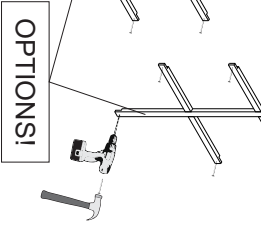
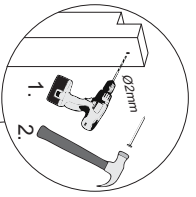
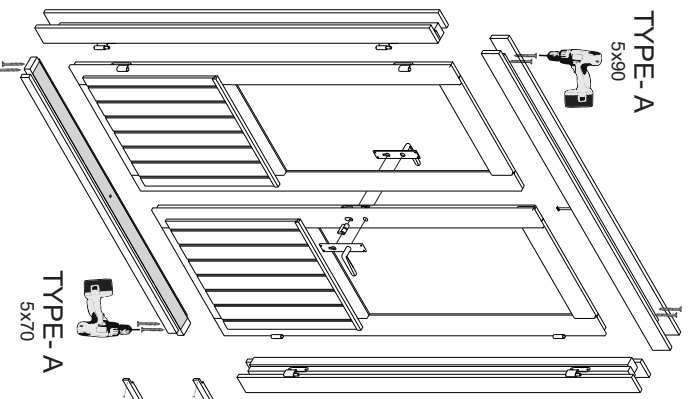
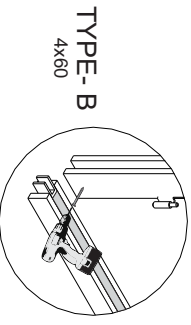
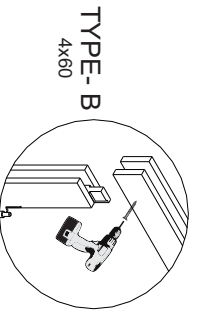
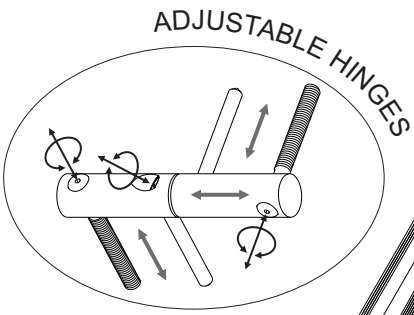
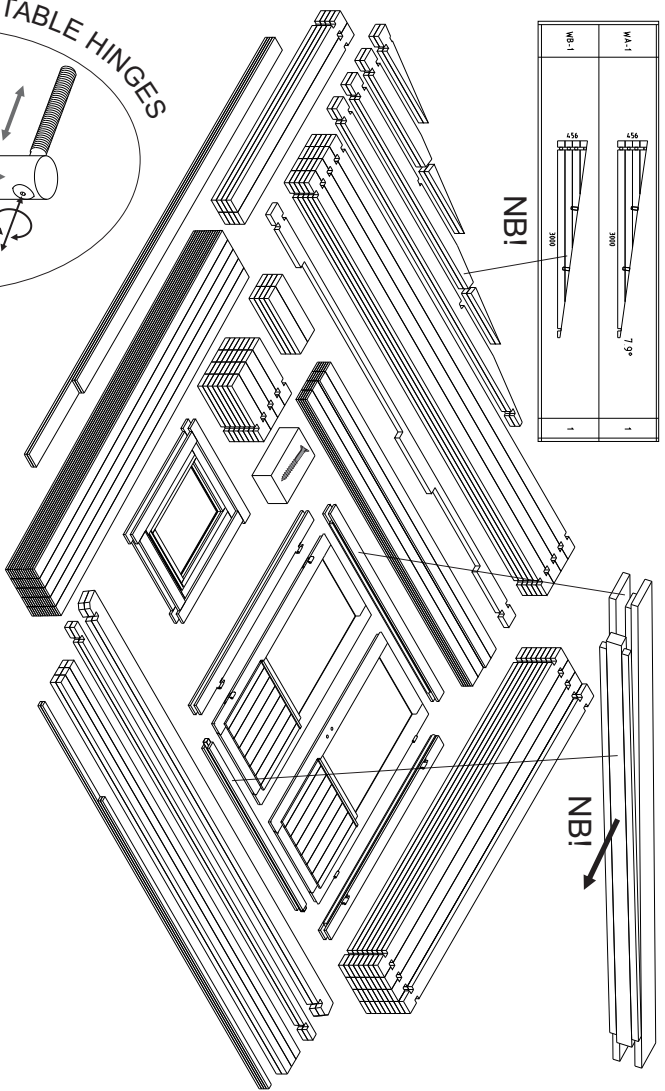

3

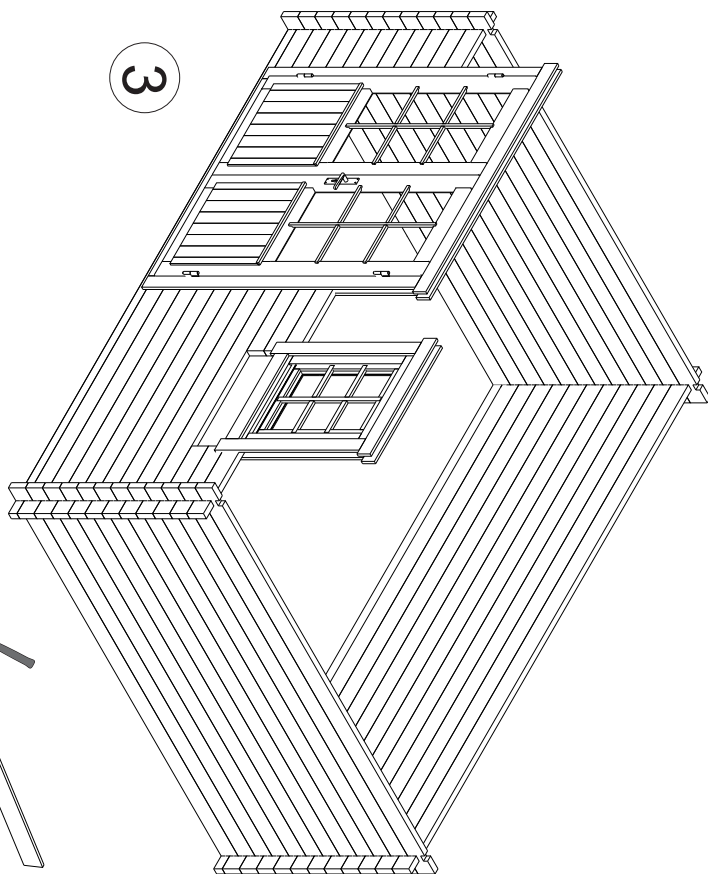

4

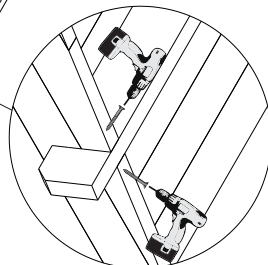
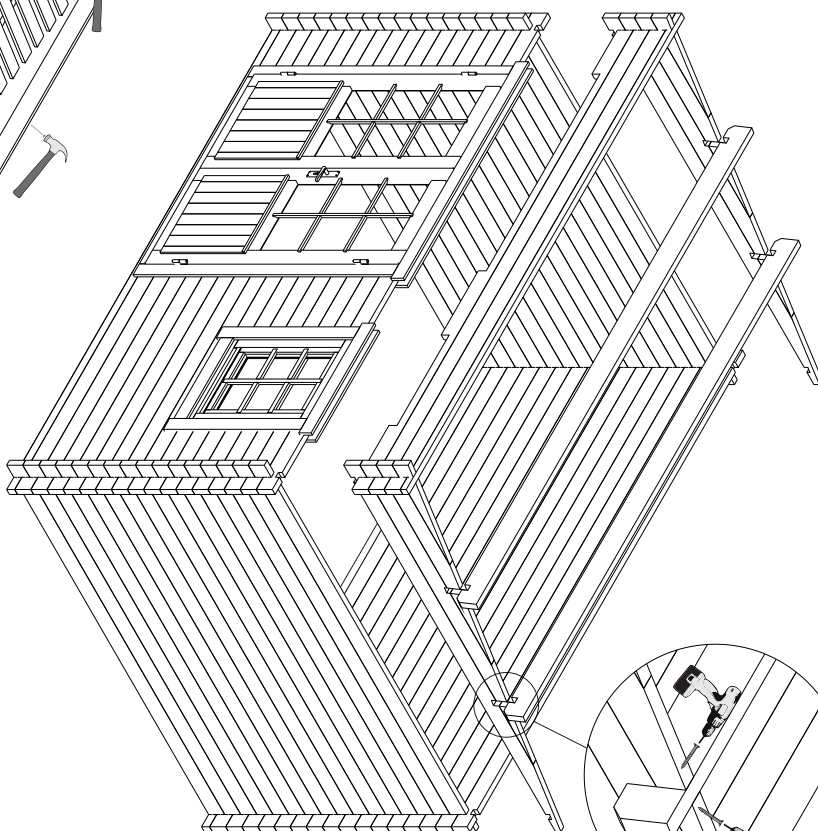

5

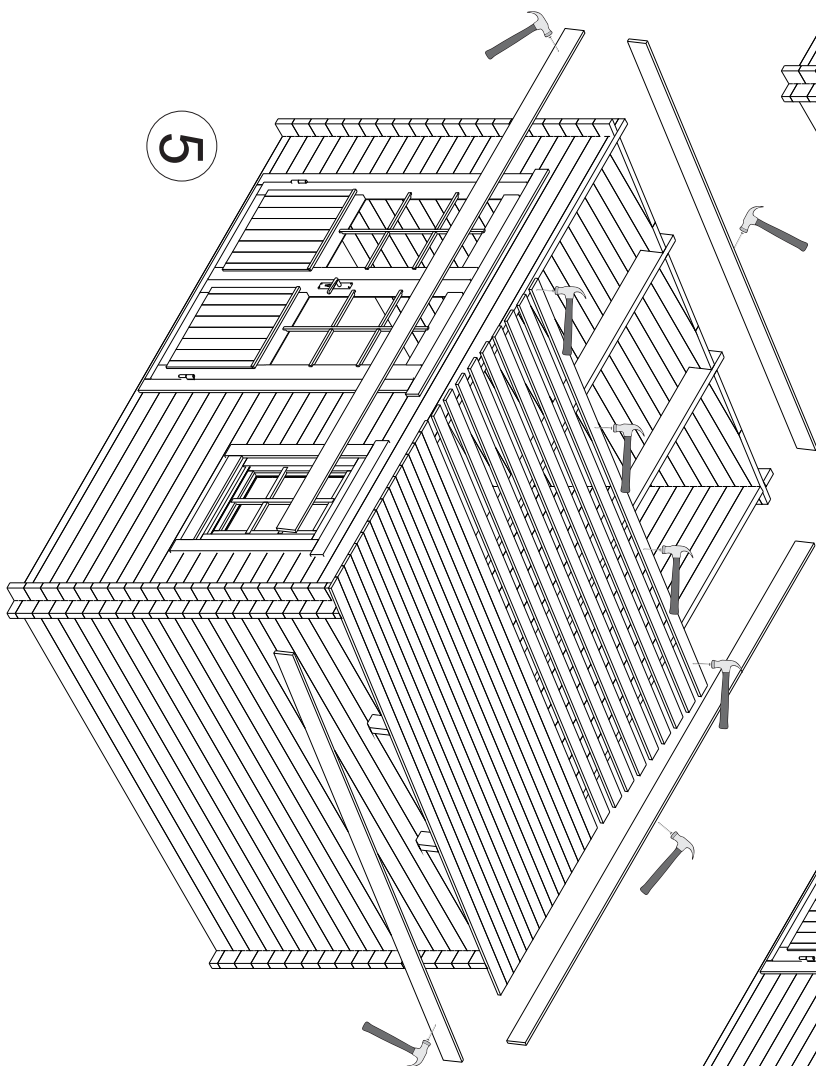

Cutting support post / Schneiden der Stützpfosten



- * Adjustment space for post support should be at least 50mm.
- * Einstellraum für die Pfostenstütze muss mindestens 50mm sein.

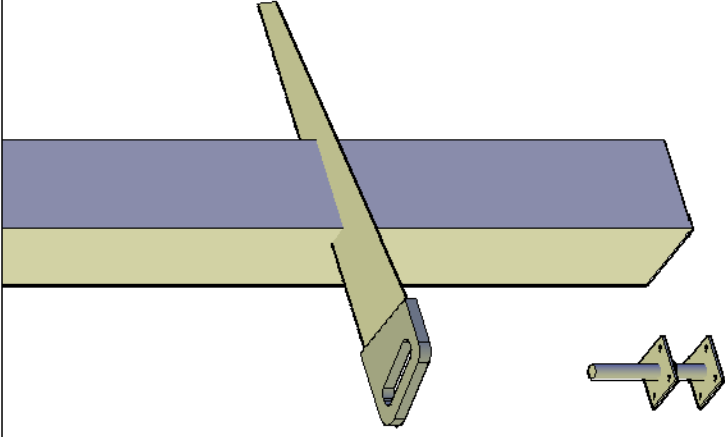

- * Support post has extra length for various conditions. Must be sawn to suitable length on spot considering local conditions.
- * Stützpfosten hat extra Länge für verschiedene Bedingungen. Muss vor Ort unter Berücksichtigung der örtlichen Gegebenheiten zu einer geeigneten Länge gesägt werden.

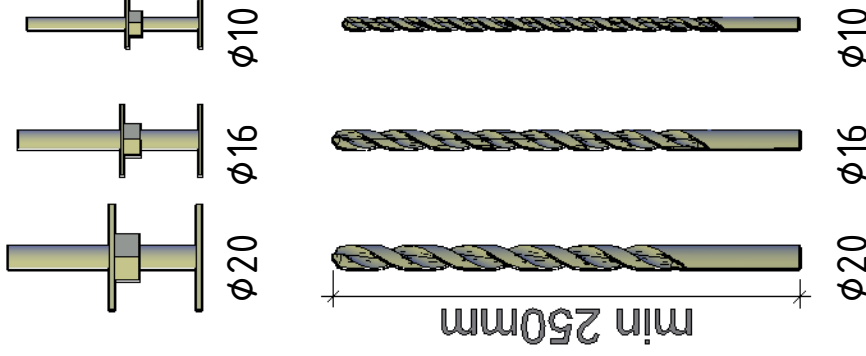

- * In some cases you need to drill a new hole for a post support. Find a matching drill bit.
- * In einigen Fällen müssen Sie ein neues Loch für die Pfostenstütze bohren. Finden Sie hier den passenden Bohrer.

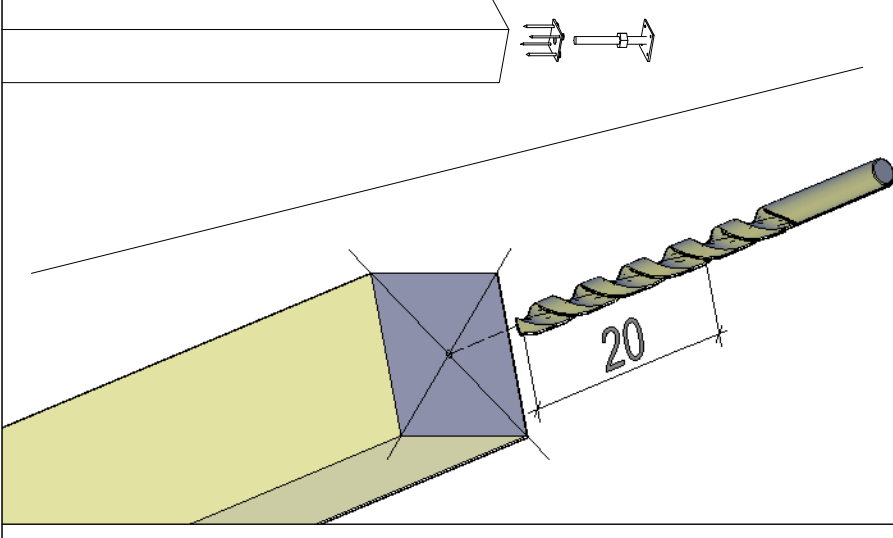

- * Mark the center of the post and drill a new 20cm deep hole.
- * Continue building.
- * Markieren Sie die Mitte des pfostens und bohren Sie ein neues 20cm tiefes Loch. Danach mit Aufbau weiter machen.