

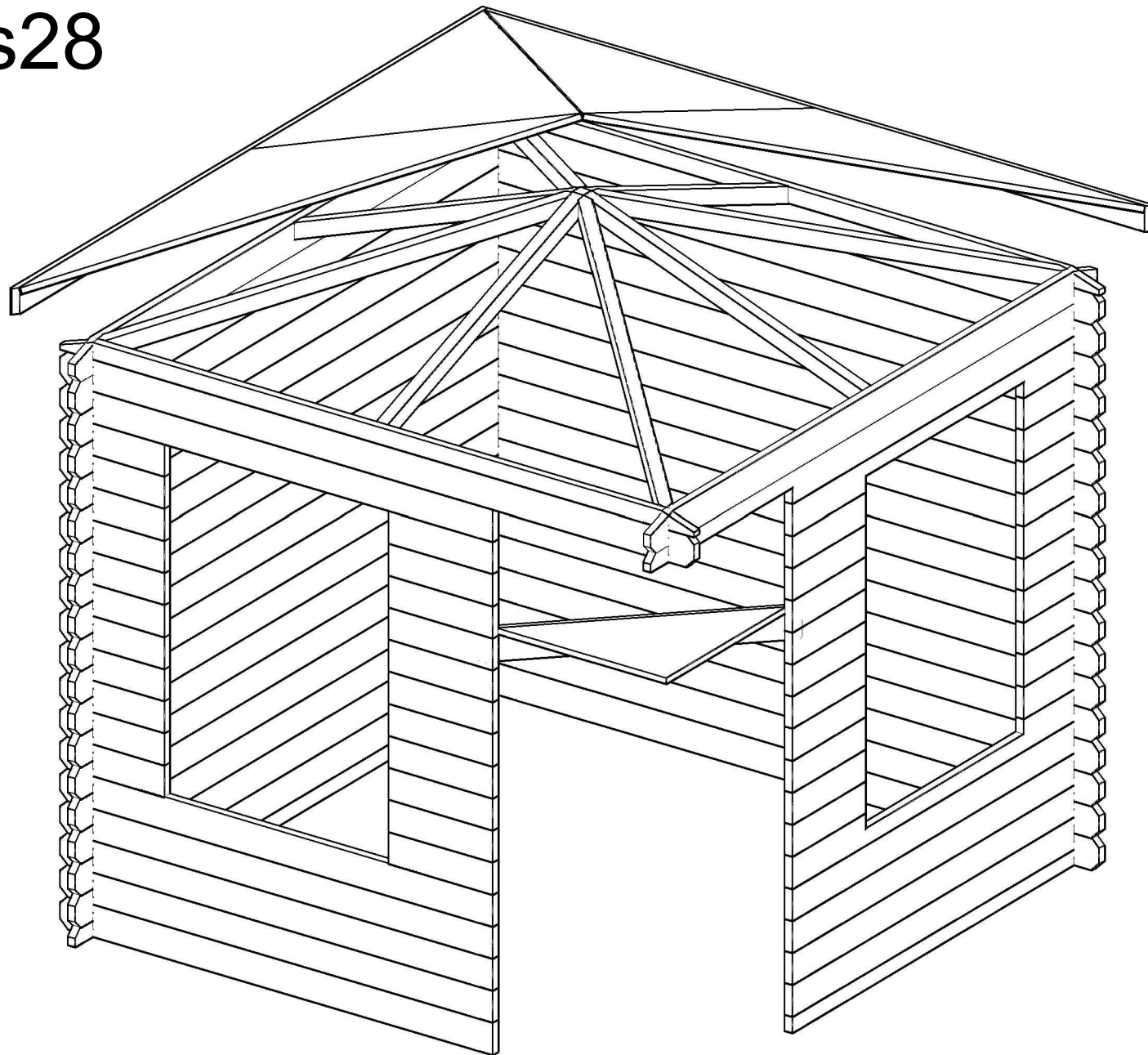

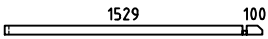

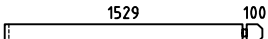

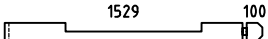



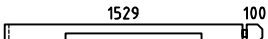
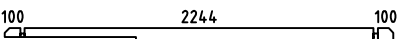
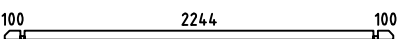
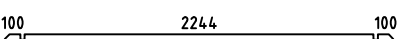

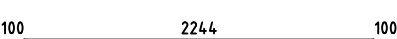
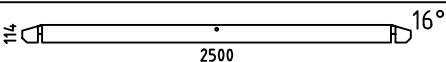
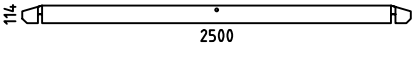
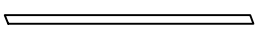
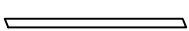



Jos28

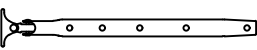

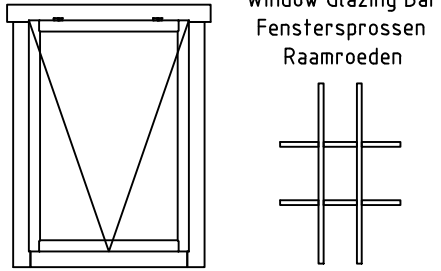
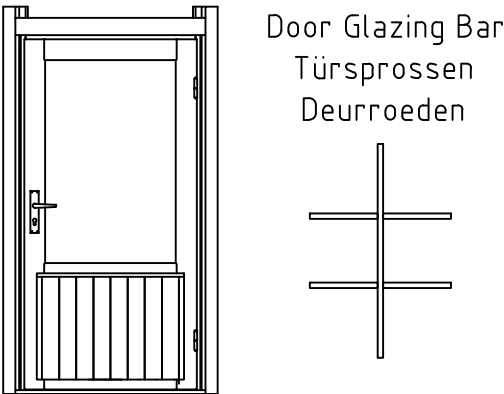
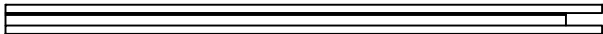
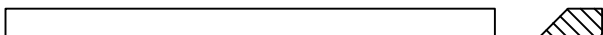
Pos	Specification-Spezifikation-Specificatie	St.	Profile (mm)	Length (mm)
001		1	28x57	1657
002		10	28x114	1657
003		1	28x114	1657
004		21	28x114	390
005		10	28x114	390
006		1	28x114	1657
007		1	28x114	2500
009		1	28x57	2500
010		36	28x114	2500
011		11	28x114	390
012		2	28x57	2500
W1-1		1		
W2-1		1		
SR2	RAFTER-DACHSPARREN-DAKSPAR 	4	44x55	1601
SR1	RAFTER-DACHSPARREN-DAKSPAR 	4	44x55	1167
PE1	Ceiling Element-Deckenelement-Plafond Element 1 	1	616x871	
L-1	Eave Slat-Traufenleiste-Afdekljst 	4	40x18	2750
	Roof Panel-Dach Elemente-Dakpanelen 	4+4	1417x1360	
	Door Set-Tür Satz-Deur Set 	1		
	Nail-Nagel-Spijker 1.2x20 	20	1.2x20	
N1	Ridge piece-Firstelement-Nokstuk 	1		
WS1	Window Stay-Fensterfeststelle 	2		
HS1	Wood Bolt set-Holzschraubesatz-Hout Bout 8x80 	4		
Kood	Materjal	File	Jos28.dwg	Leht 1/2

Pos	Specification-Spezifikation-Specificatie	St.	Profile (mm)	Length (mm)
W9N 86.5 x122.5	<p>WINDOW 865x1225</p>  <p>Window Glazing Bar Fenstersprossen Raamroeden</p>	2		
SD6P 97.2x 184 R	<p>DOOR 972x1840</p>  <p>Door Glazing Bar Türsprossen Deurroeden</p>	1		
	CORNER DOOR SET			
1-2	Post Set 	1+1	42x61	1840
3-4	Cover Slat 	2	40x18	1810
5-6	Casting 	2	18x95	1050
	Screw-Schraube-Schroef 4x60 	12		
	Screw-Schraube-Schroef 5x80 	16		
Kood	Materjal	File	Jos28.dwg	Leht 2/2

H = 1.200 m
 TOTAL: 4.78 m²

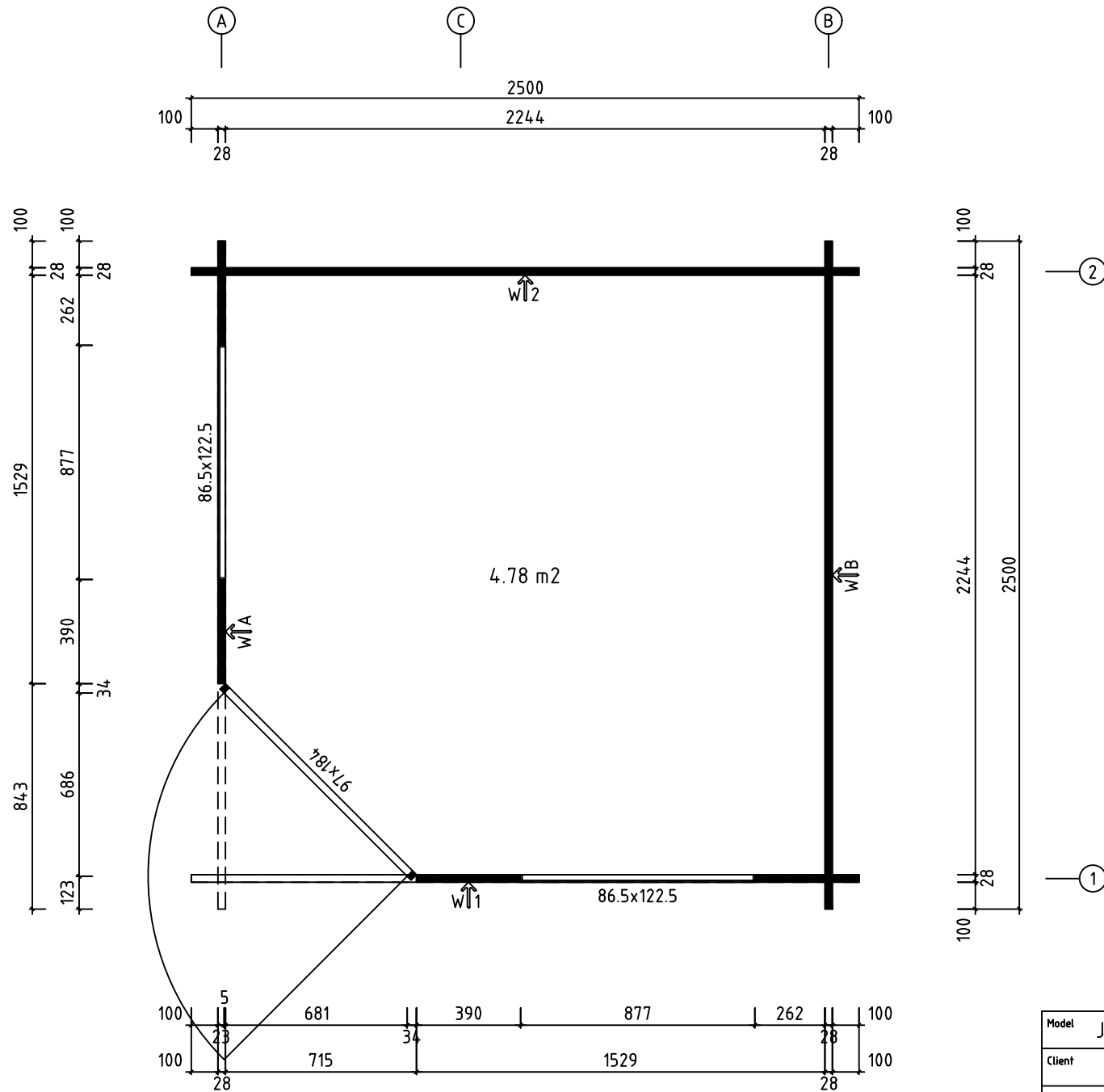

Model	Jos28	Page	PLAN
Client		Scale	1:20
Material	28x114	Date	17.10.2018
Company	File Jos28.dwg		

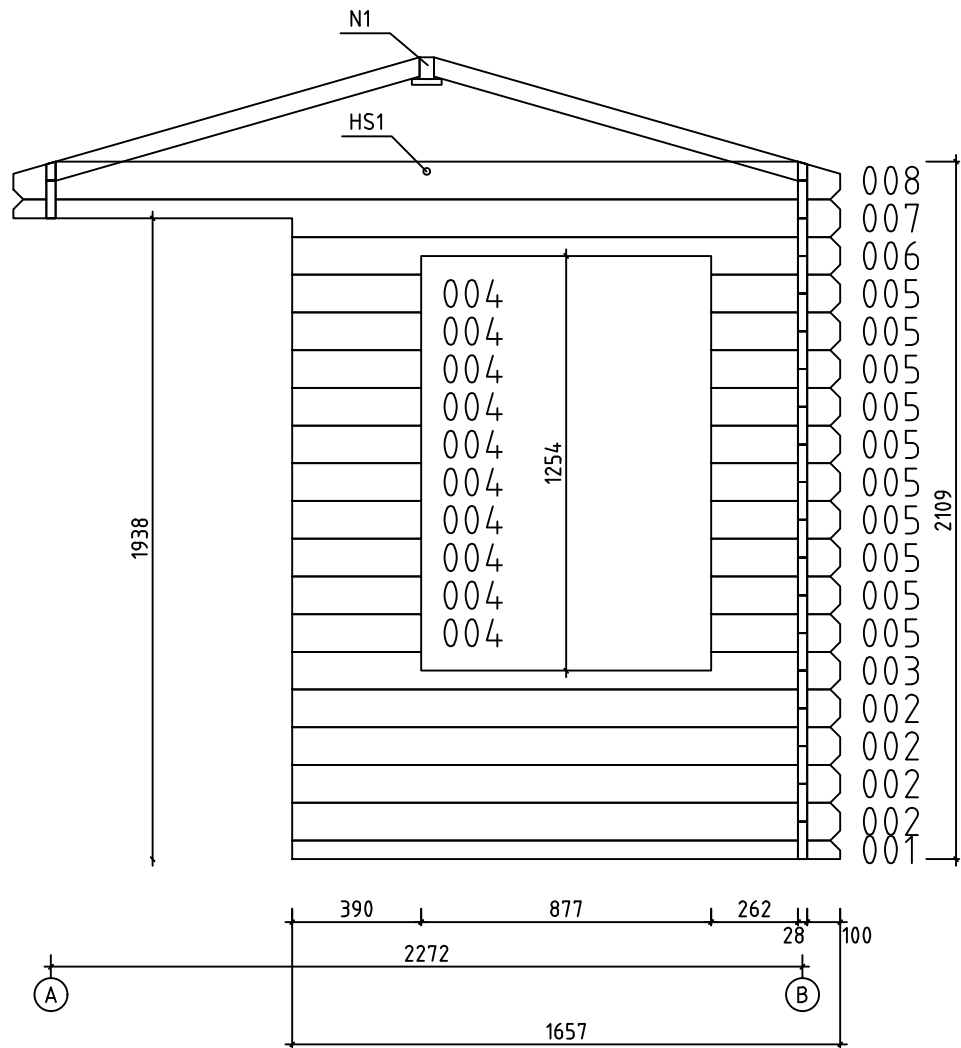

Wall-Wand 1 ↗

Model	Jos28	Page	5
Client		Scale	1:20
Material	2.8x11.4	Date	17.10.2018
Company		File	Jos28.dwg

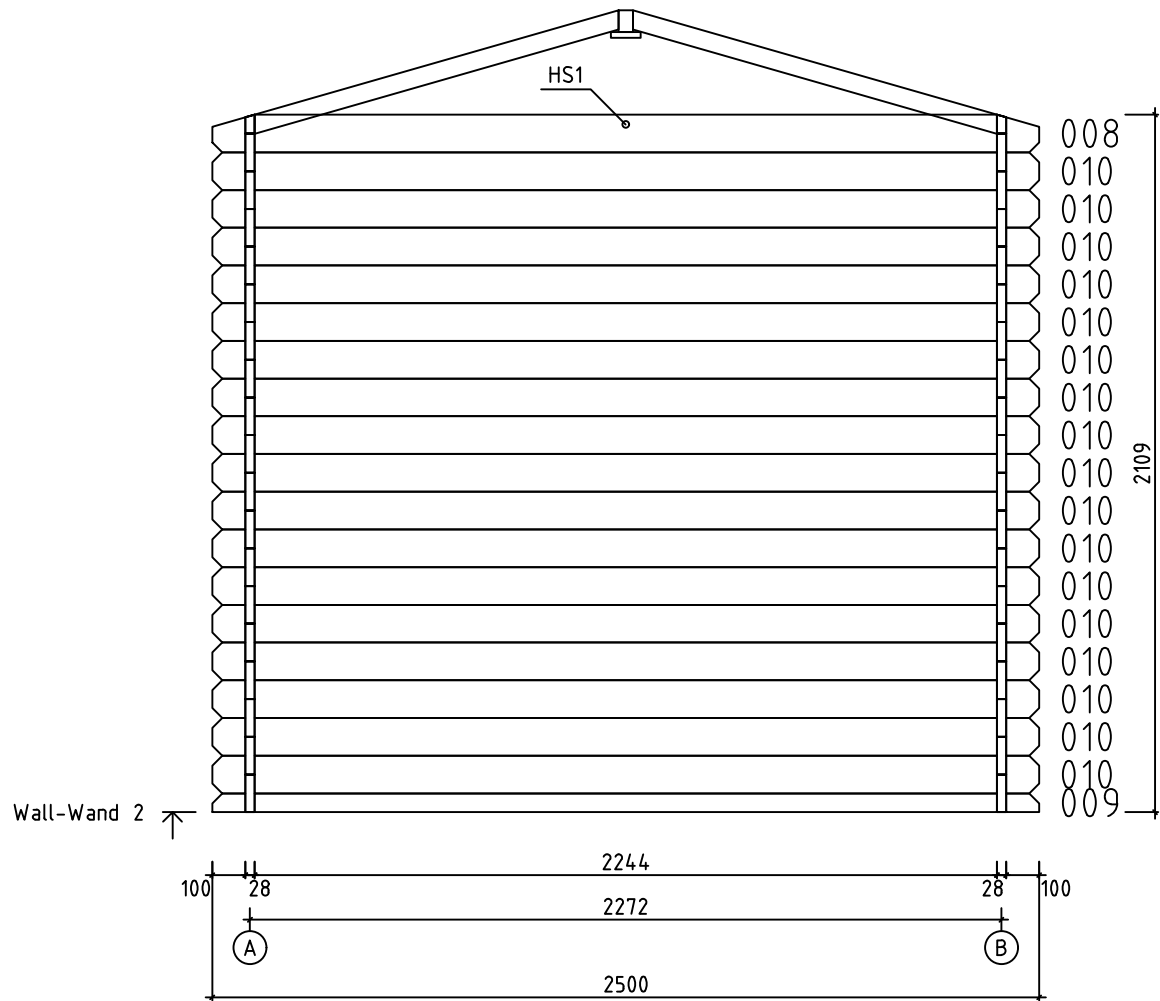

Model	Jos28	Page	6
Client		Scale	1:20
Material	2.8x11.4	Date	17.10.2018
Company		File	Jos28.dwg

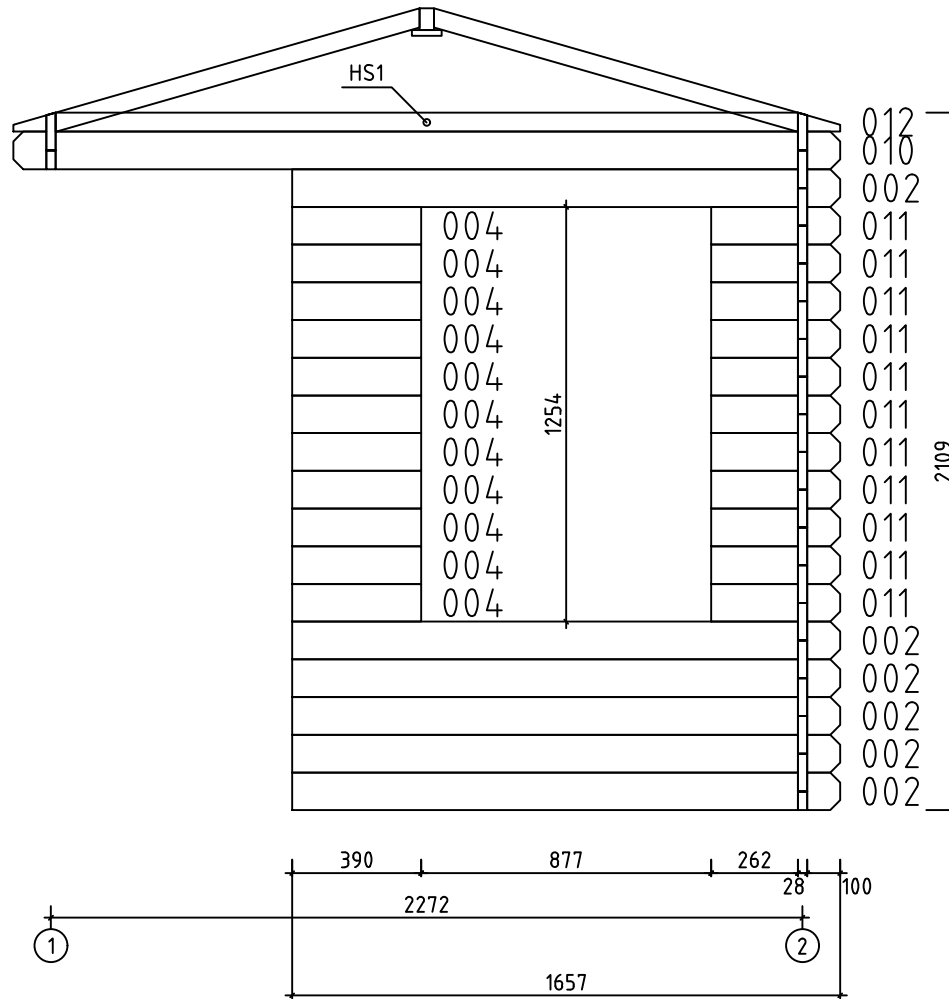

Wall-Wand A ↗

Model	Jos28	Page	2
Client		Scale	1:20
Material	2.8x11.4	Date	17.10.2018
Company		File	Jos28.dwg

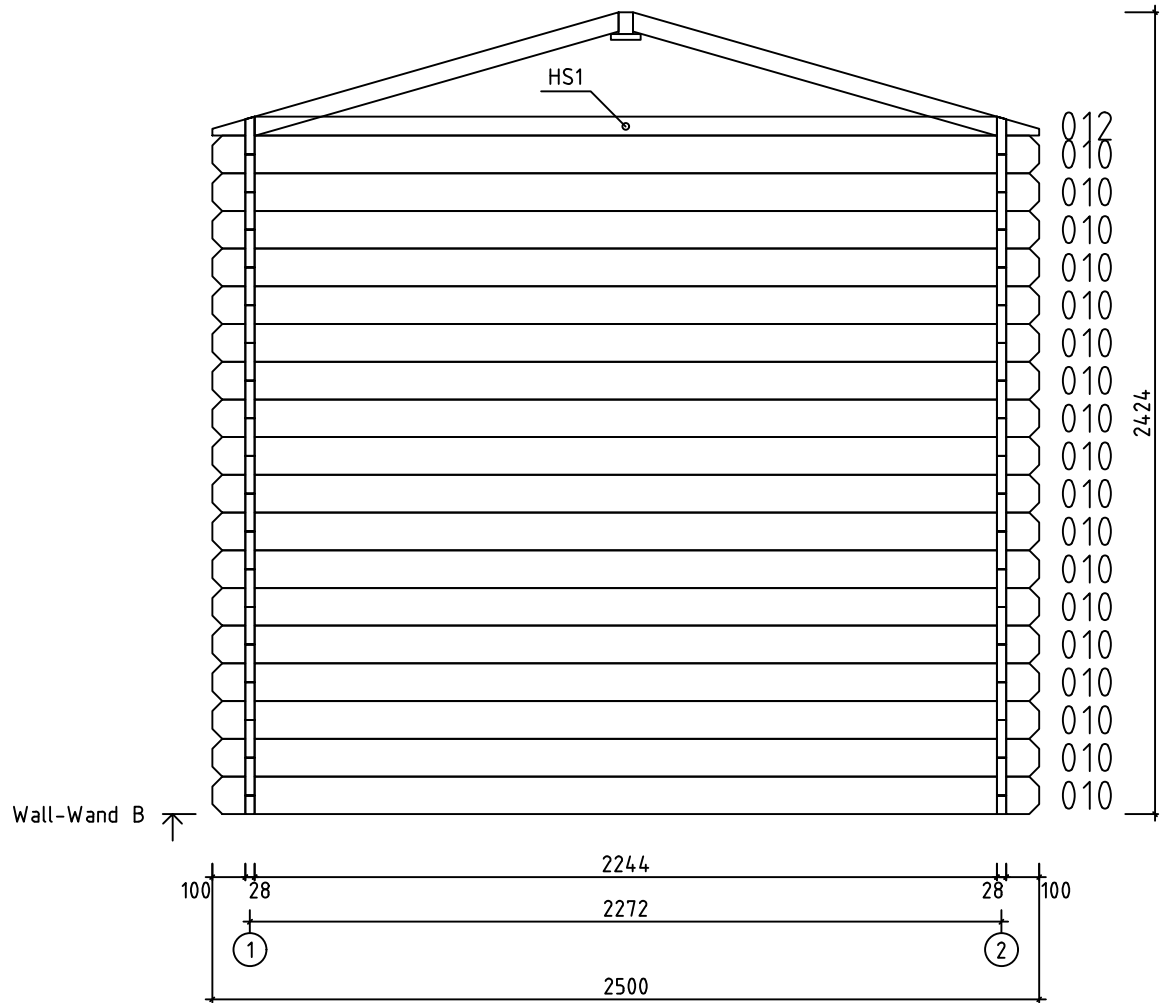

Model	Jos28	Page	3
Client		Scale	1:20
Material	2.8x11.4	Date	17.10.2018
Company		File	Jos28.dwg

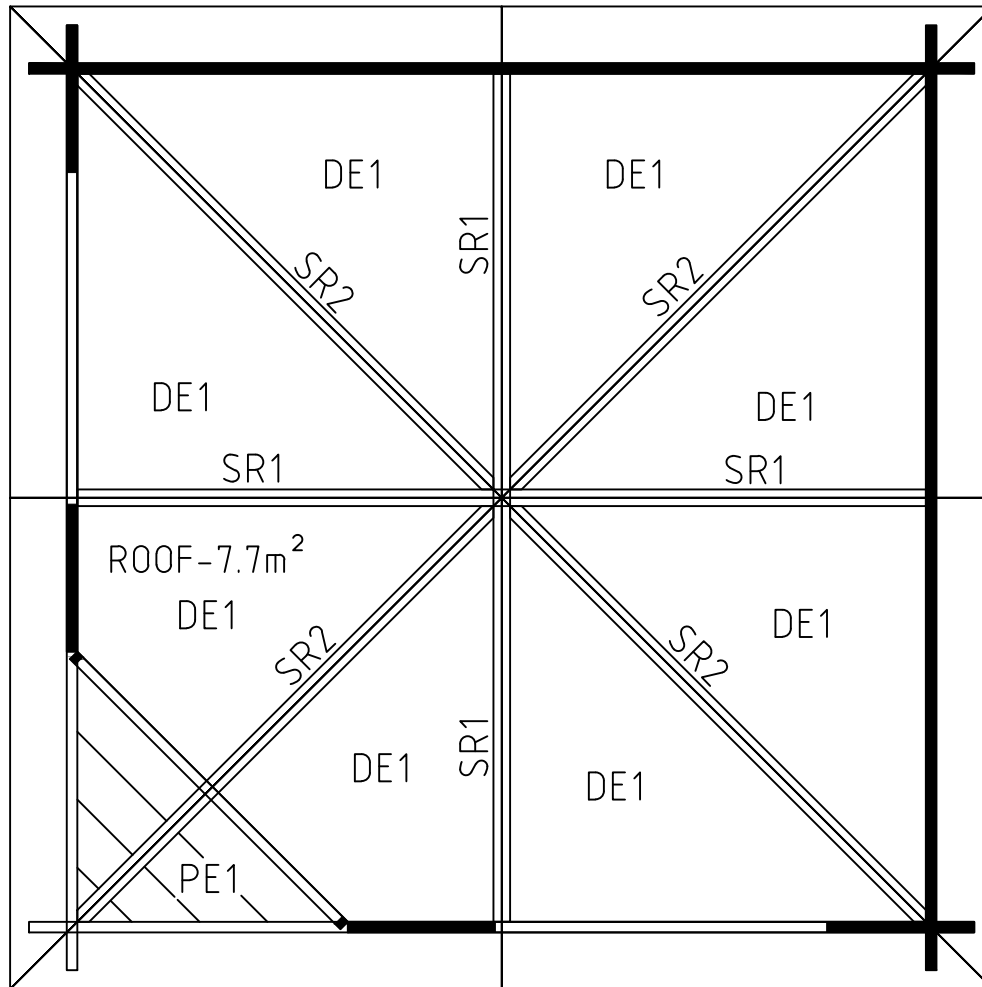

Model	Jos28	Page	ROOF
Client		Scale	1:20
Material	28x114	Date	17.10.2018
Company		File	Jos28.dwg

The guide is illustrative. This guide is not project specification.
Der Leitfaden ist illustrativ. Dieser Leitfaden ist keine Projektspezifikation.
De gids is illustratief. Deze gids is geen projectspecificatie.

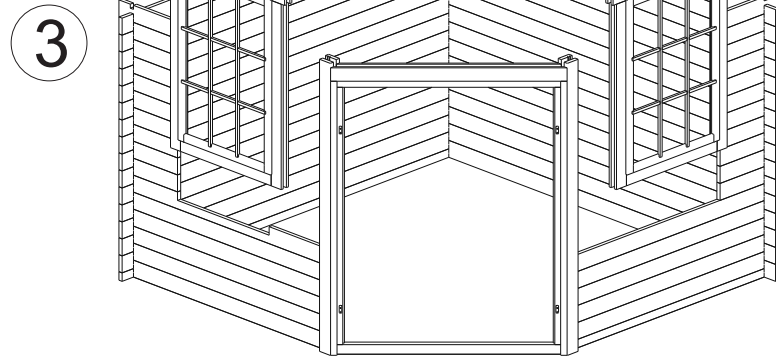
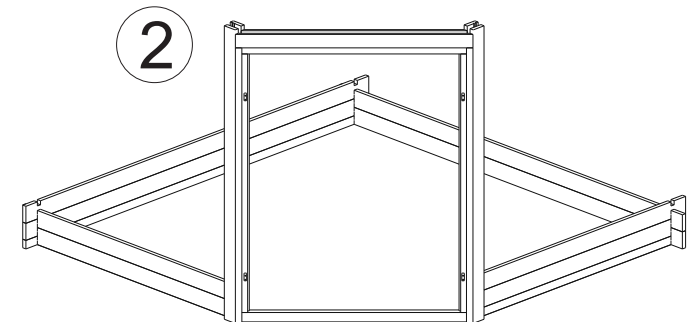
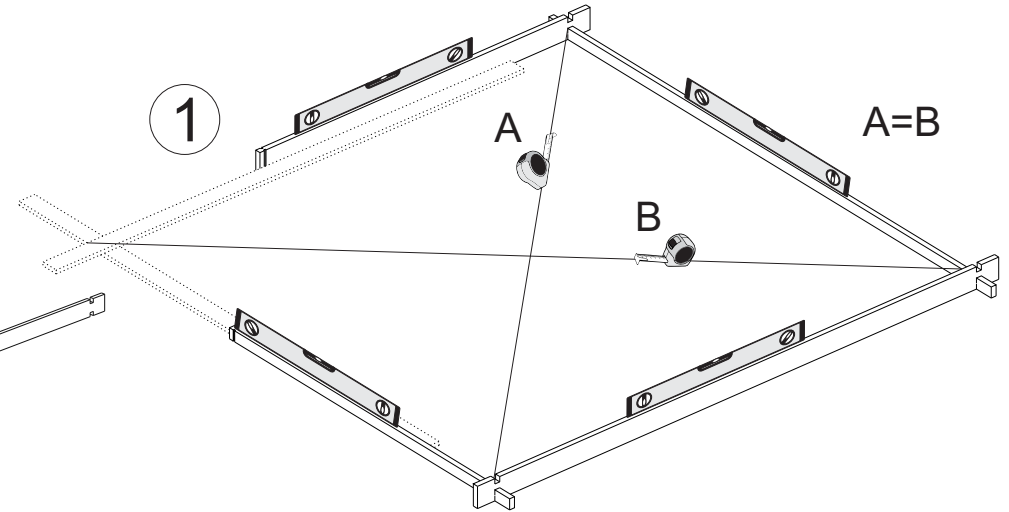
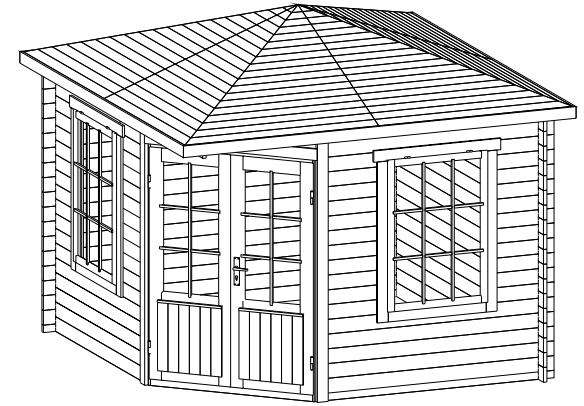
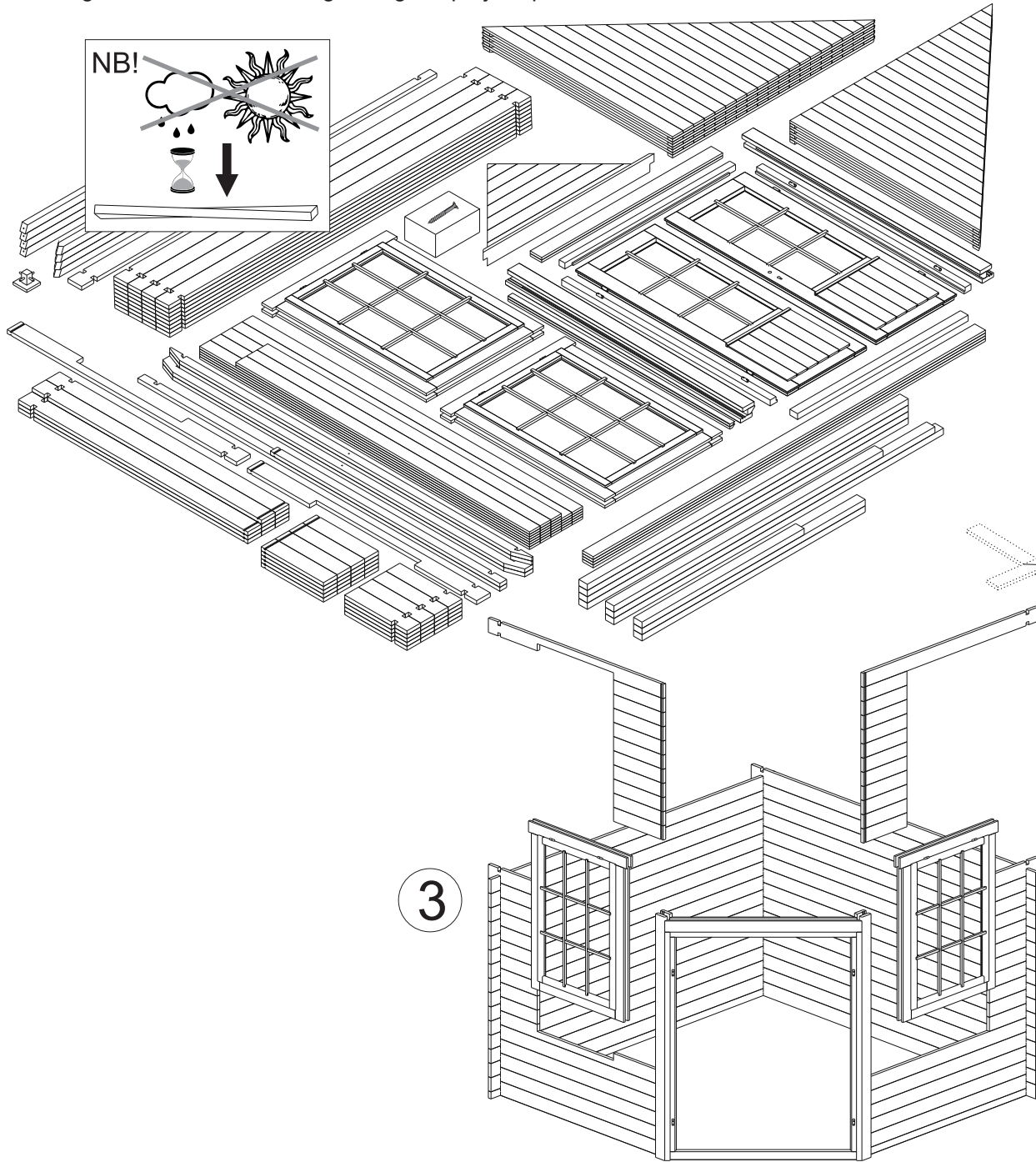

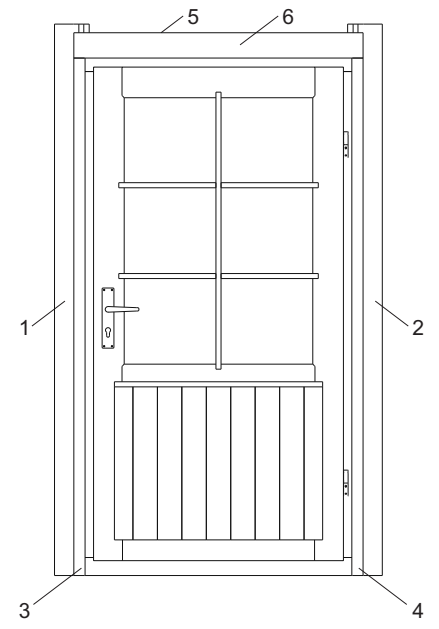
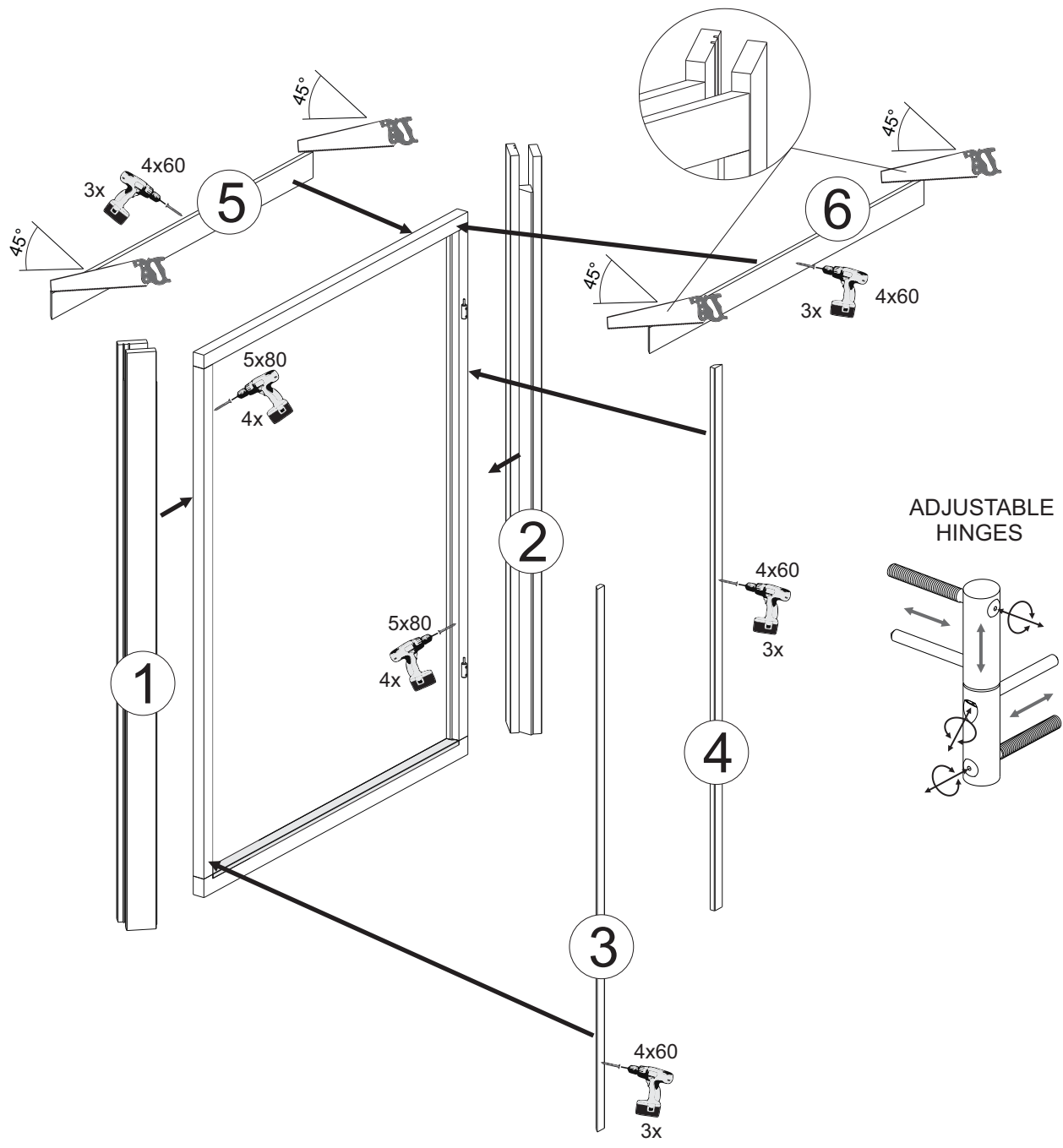

ADJUSTABLE HINGES

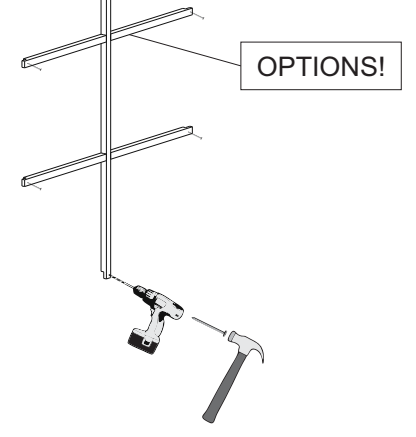
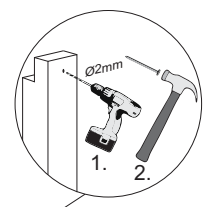
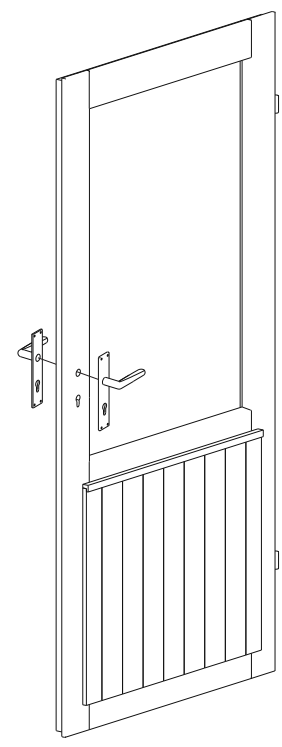
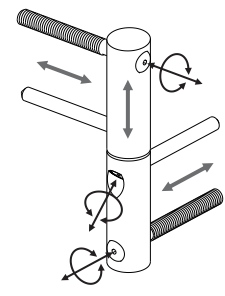

4

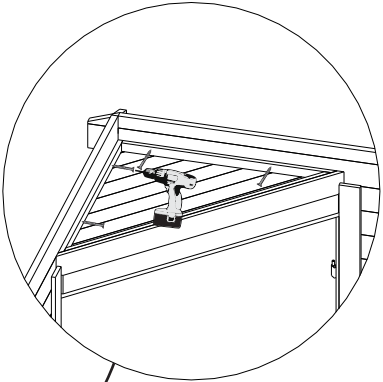
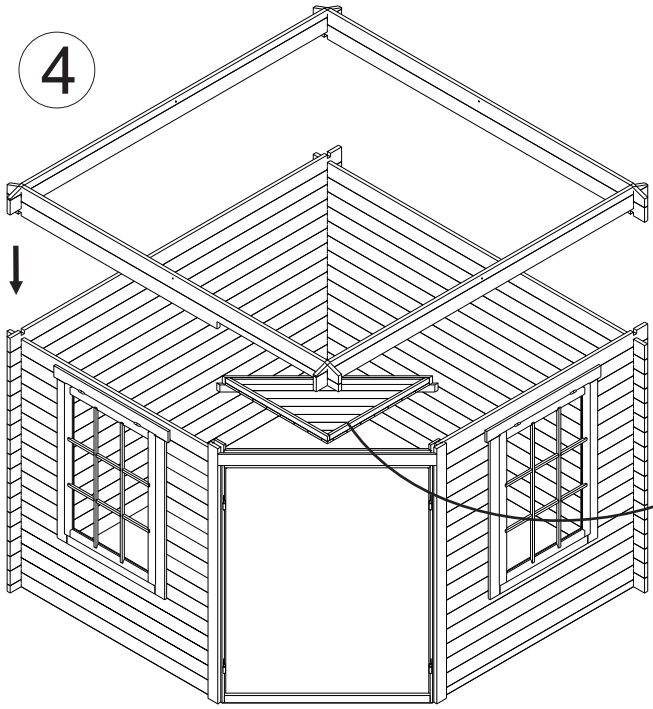

5

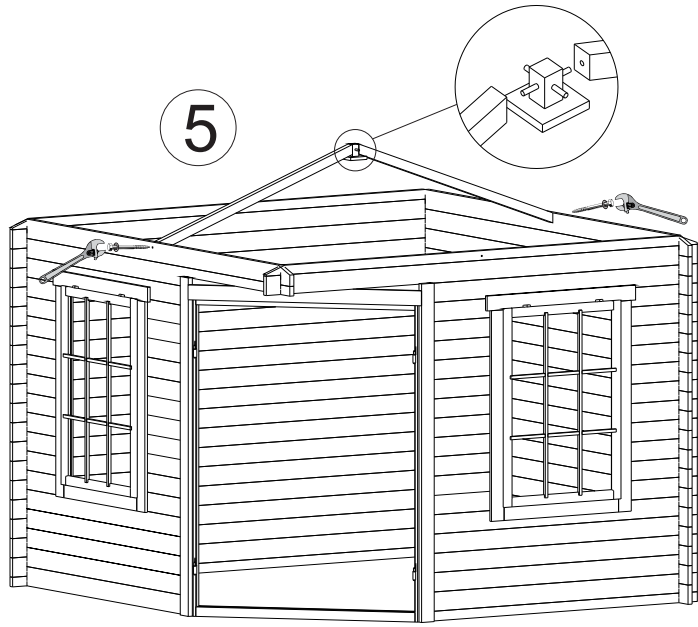

6

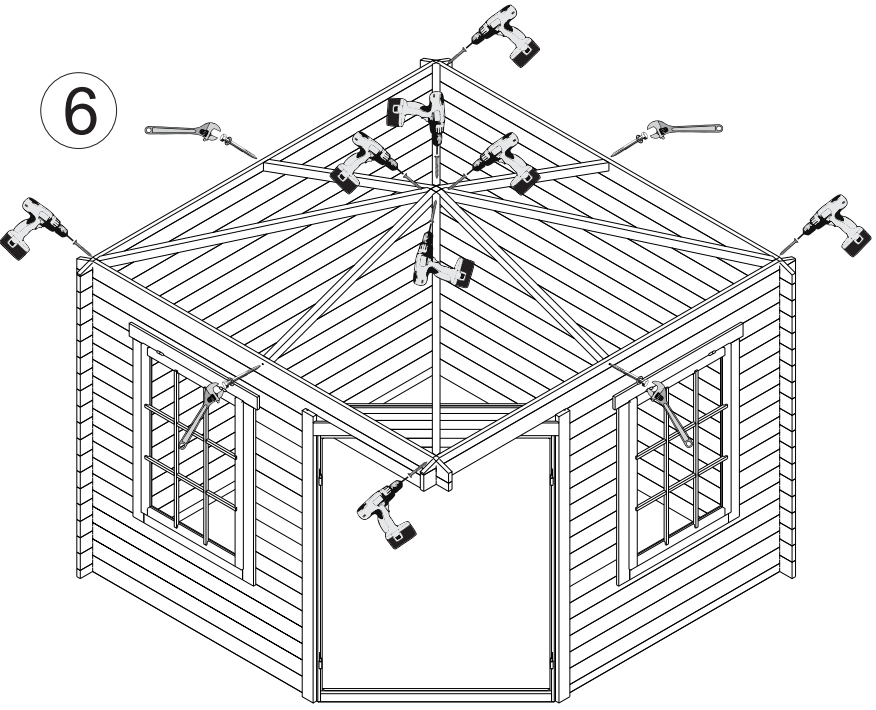

7

