

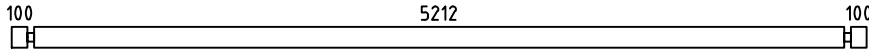

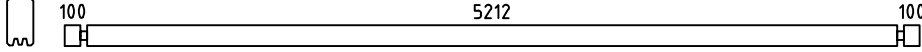

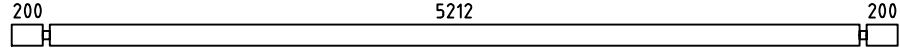

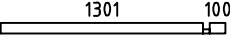



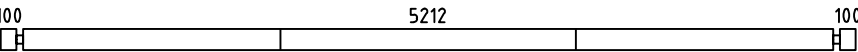
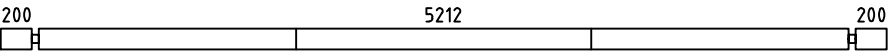
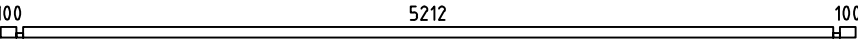
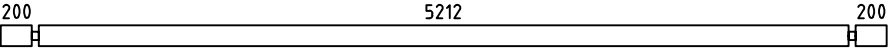
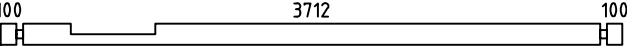
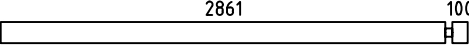
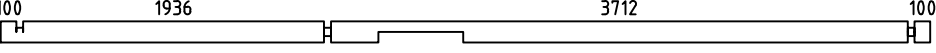
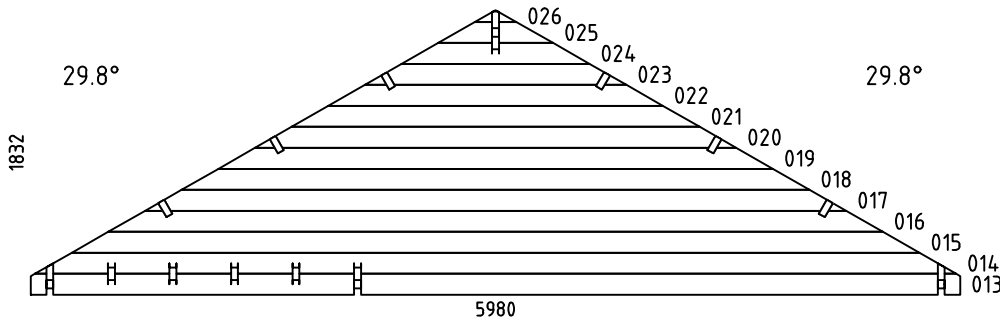
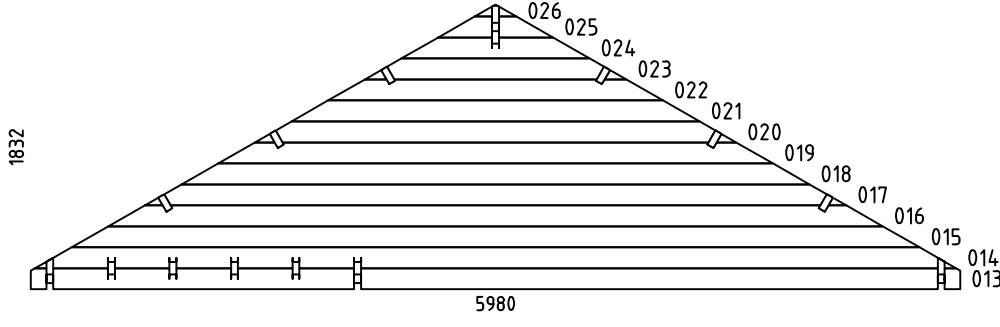
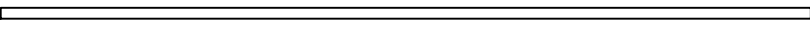
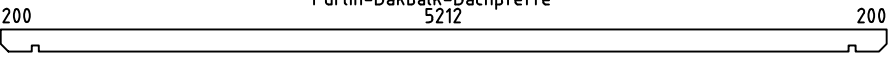
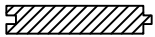
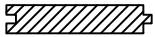
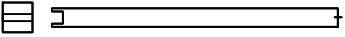
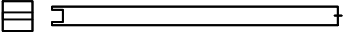

Olaug44ISO

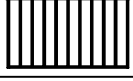
Pos	Specification-Spezifikation-Specificatie	St.	Profile (mm)	Length (mm)
001		17	44x135	5500
001A		5	44x135	5500
002		1	44x135	5700
003		2	44x68	1445
004		54	44x135	450
005		28	44x135	450
006		1	44x135	5500
007		1	44x130	5700
008		1	44x68	5500
009		1	44x135	5700
010		2	44x135	4000
011		26	44x135	3005
012		2	44x135	5980
WA-1		1		
WB-1		1		
LT1	CEILING BEAM-DECKENBALKEN-PLAFOND BEAM 	1	44x70	5212
PR1	Purlin-Dakbalk-Dachpfette 	6	44x144	5700
Code	Material	File	Olaug44ISO.dwg	Page 1/3

Pos	Specification-Spezifikation-Specificatie	St.	Profile (mm)	Length (mm)
CB-1	Ceiling-Decke-Plafond 	60	88x18	1970
DP-1	Roof board-Dachbrett-Dakplank 	130+2	88x18	3660
	-POST 85x85 	2		2185
	-POST 85x85 	2		2250
L-1	Eave Slat-Traufenleiste-Afdekljst 	2	40x18	5700
L-2	Facia Board-Giebelblende-Gevelplank 	4	18x120	3700
L-3	Facia Slat-Giebelleiste-Gevellijst 	4	40x18	3700
LG1	Railig-Leuning-Geländer14 	4	1810x800	
KL-1	Threaded rod Set-Gewindestange Satz-Draadstang Set 	2		300
	Adjustable foot-Stellfuß+Schrauben 4x50 4stück für Post 	4		
D1	Diamond 	2		
	Double Door Set ISO-Doppeltür Satz-Dubbele Deur Set 	1		
	Window Handle Set-Fenstergriff Satz-Raamgreep Set 	4		
W08DK 52.5X1 85 ISO L	WINDOW 525x1850 ISO 	2		
Code	Material	File	Olaug44ISO.dwg	Page 2/3

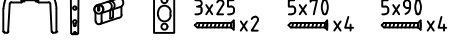
Pos	Specification-Spezifikation-Specificatie	St.	Profile (mm)	Length (mm)
W08DK 52.5X1 85 ISO R	<p style="text-align: center;">WINDOW 525x1850 ISO</p> 	2		
4DD08 260X 190 ISO	<p style="text-align: center;">DOOR 2600x1900 ISO</p> 	1		
Code	Material	File Olaug44ISO.dwg		Page 3/3

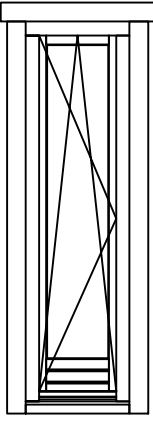
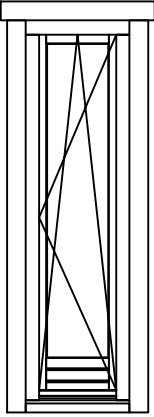
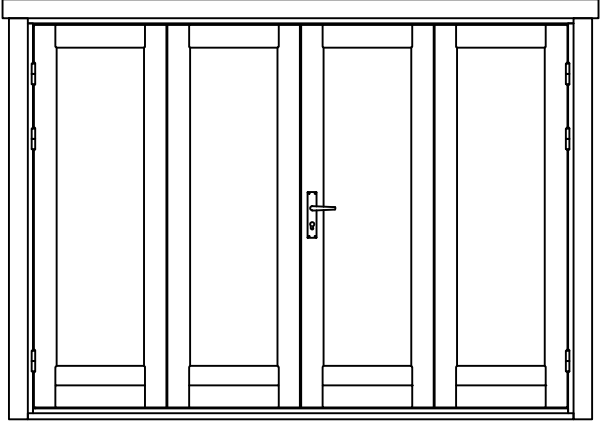
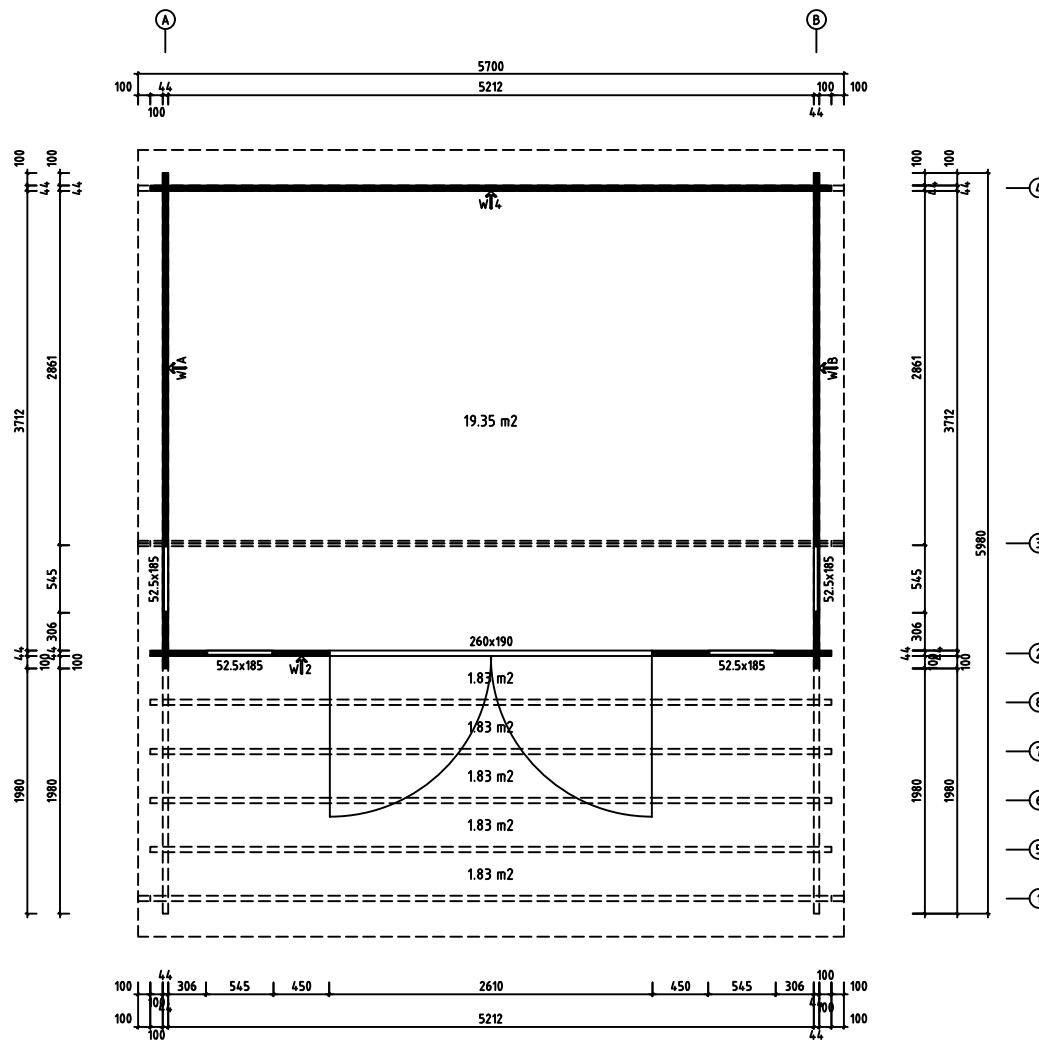

Model	Olaug44ISO	Page	PLAN
Client		Scale	1:40
Material	44x135	Date	26.08.2020
Company	Olaug44ISO.dwg		

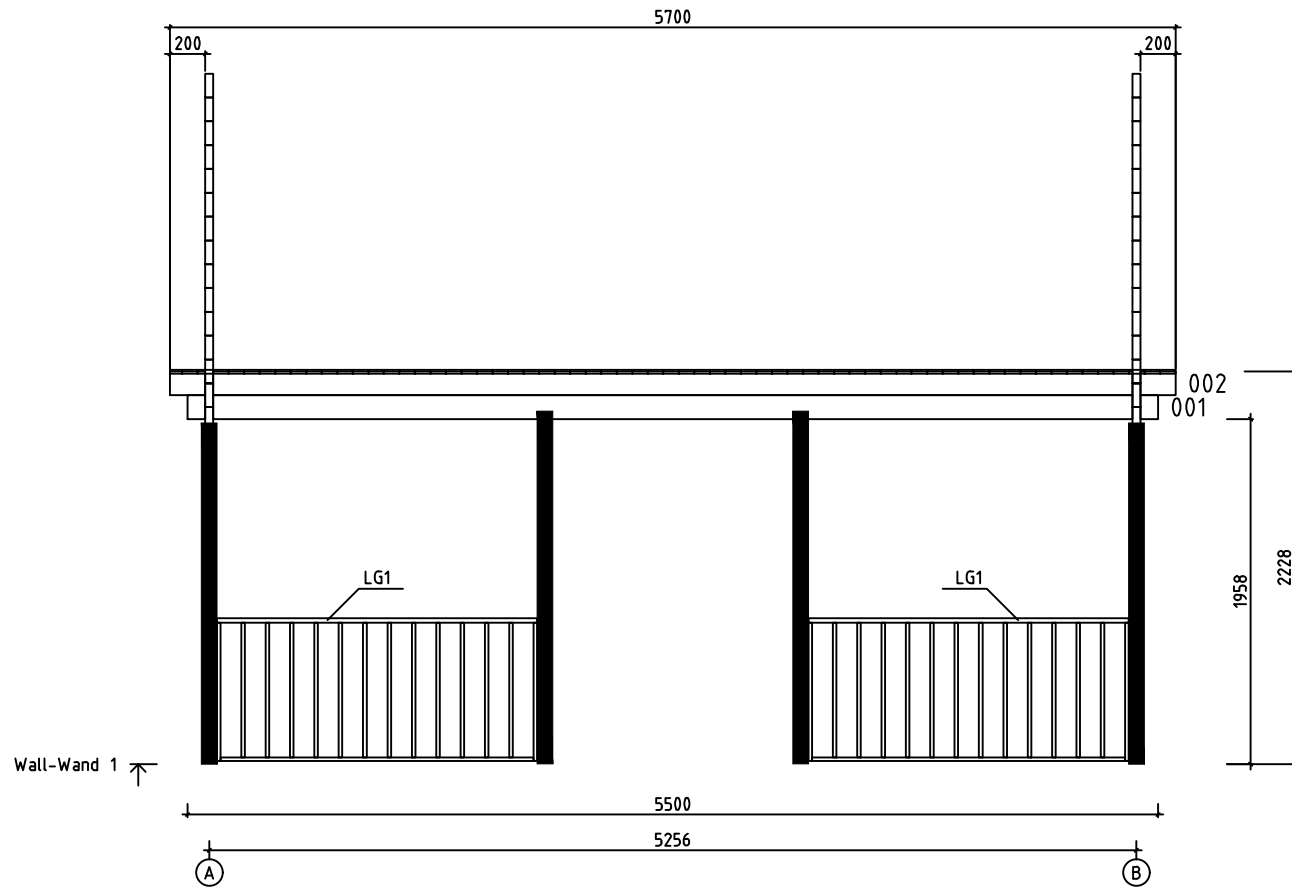

Model	Olaug44ISO	Page	4
Client		Scale	1:40
Material	4.4x13.5	Date	26.08.2020
Company		File	Olaug44ISO.dwg

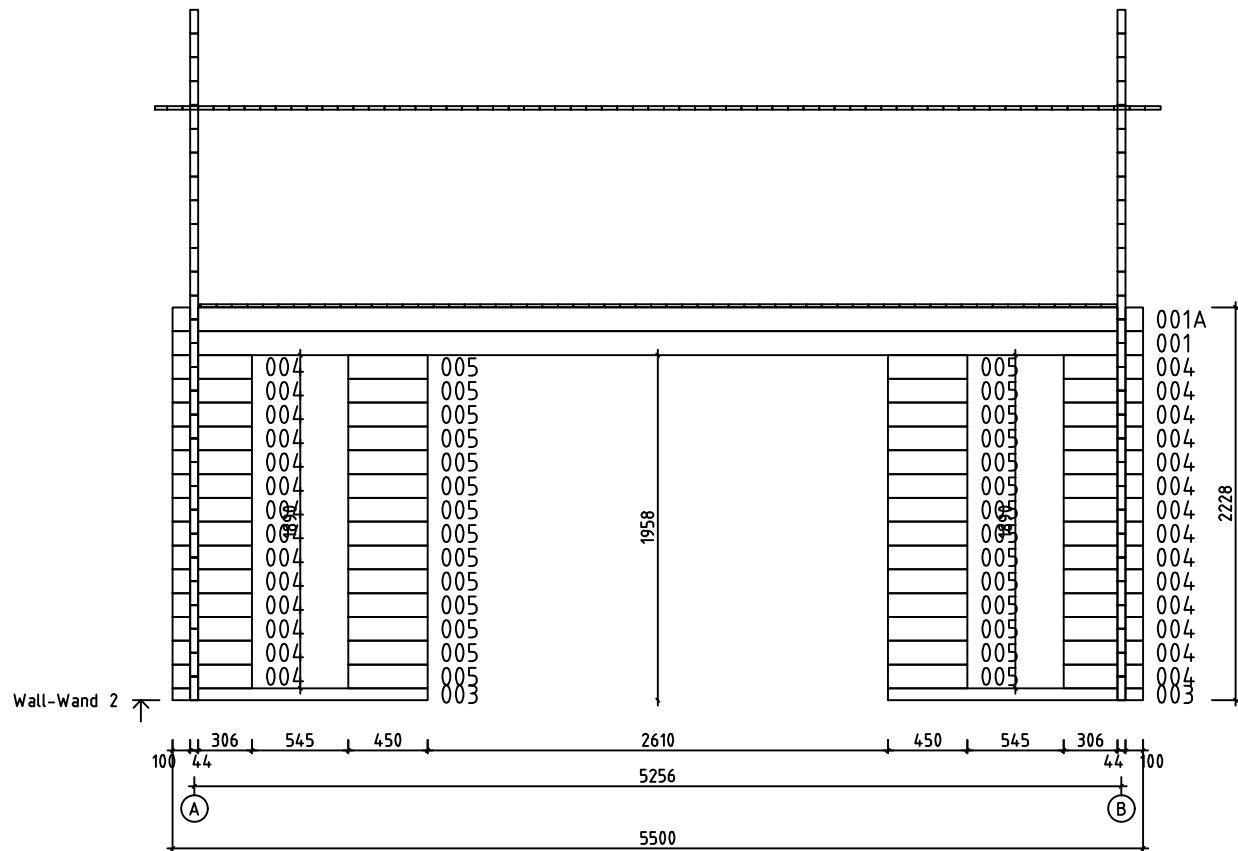

Model	Olaug44ISO	Page	5
Client		Scale	1:40
Material	4.4x13.5	Date	26.08.2020
Company		File	Olaug44ISO.dwg

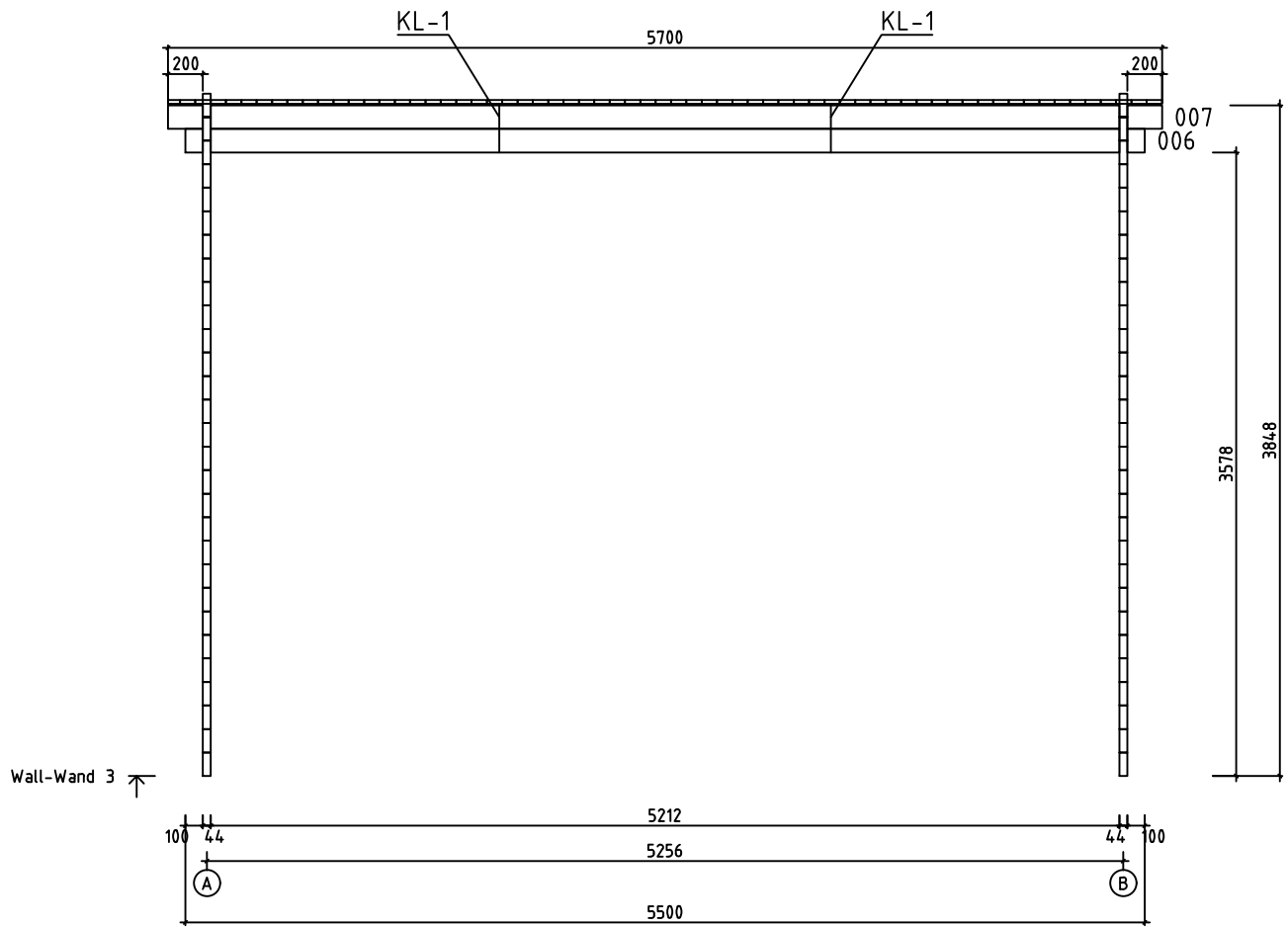

Model	Olaug44ISO	Page	6
Client		Scale	1:40
Material	4.4x13.5	Date	26.08.2020
Company		File	Olaug44ISO.dwg



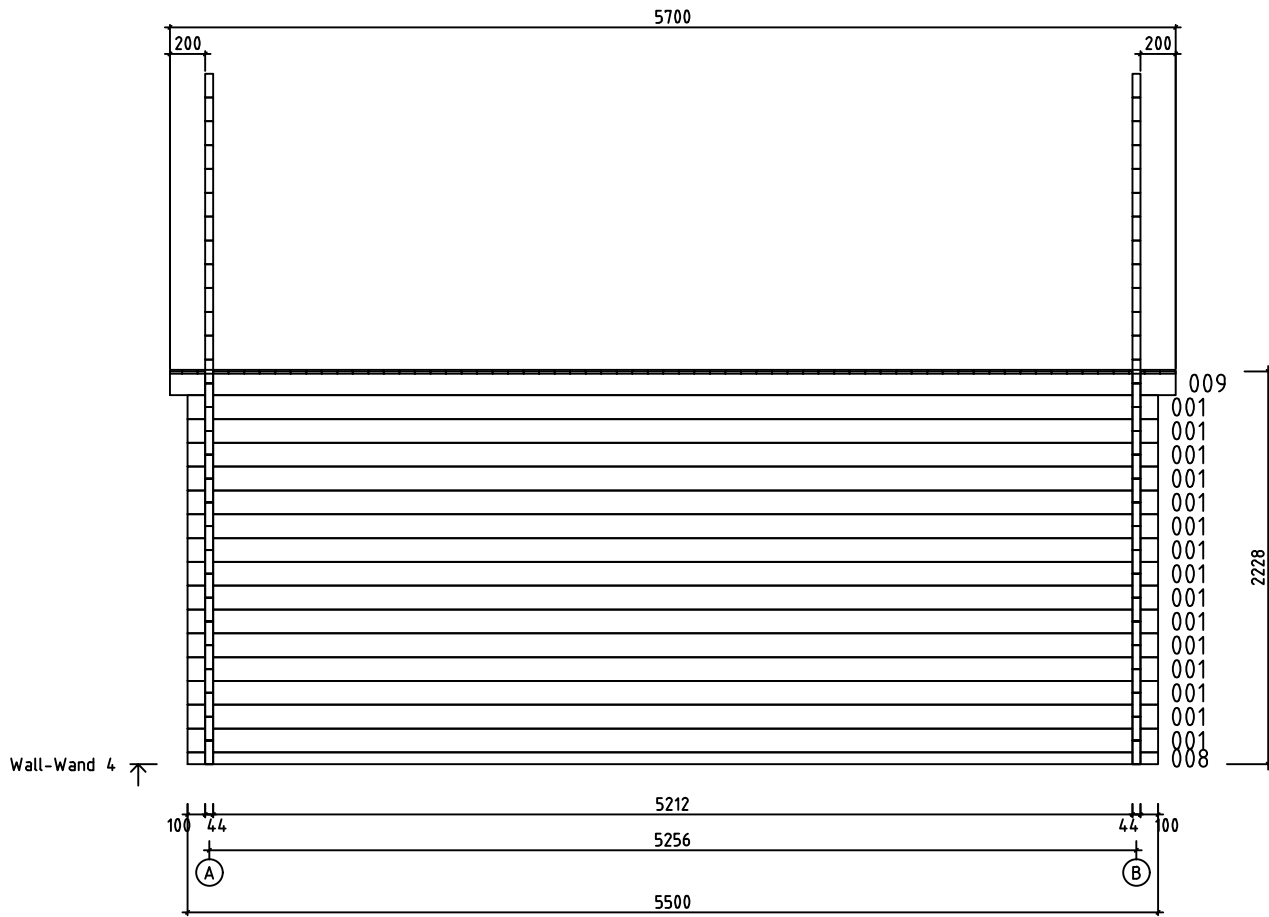

Model	Olaug44ISO	Page	7
Client		Scale	1:40
Material	4.4x13.5	Date	26.08.2020
Company		File	Olaug44ISO.dwg

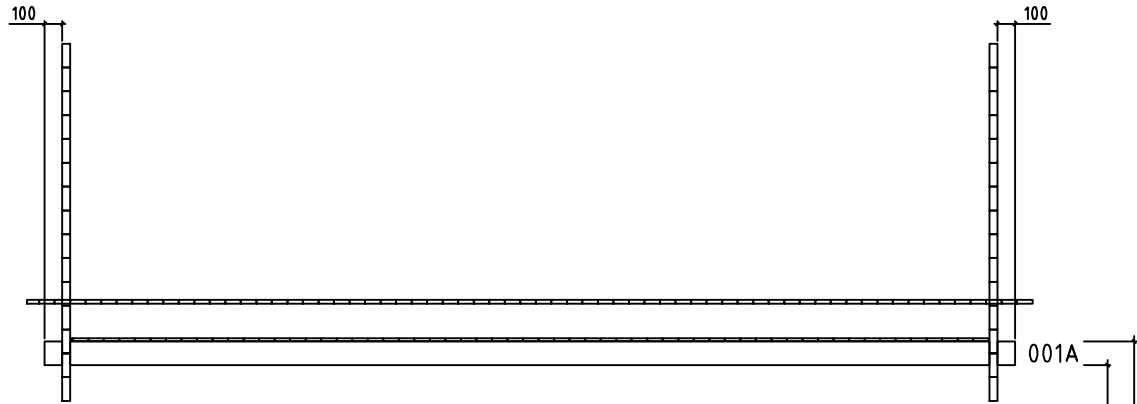

Wall-Wand 5 ↗

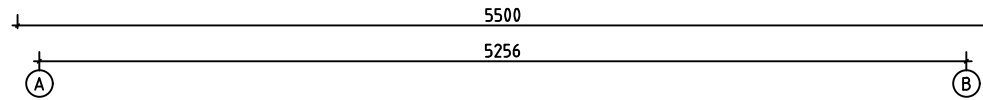

Model	0laug44ISO	Page	8
Client		Scale	1:40
Material	4.4x13.5	Date	26.08.2020
Company		File	0laug44ISO.dwg

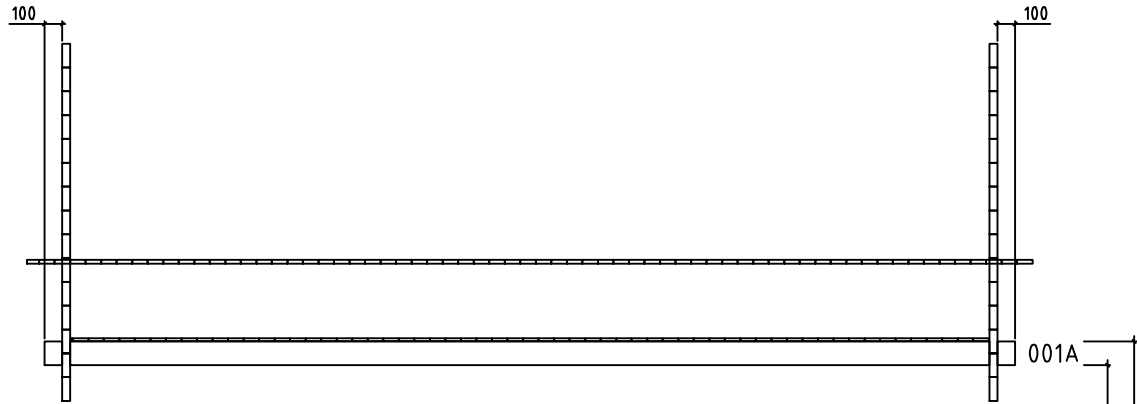

Wall-Wand 6 ↗

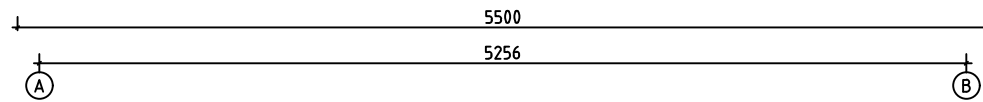

Model	Olaug44ISO	Page	9
Client		Scale	1:40
Material	4.4x13.5	Date	26.08.2020
Company		File	Olaug44ISO.dwg

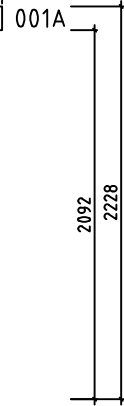
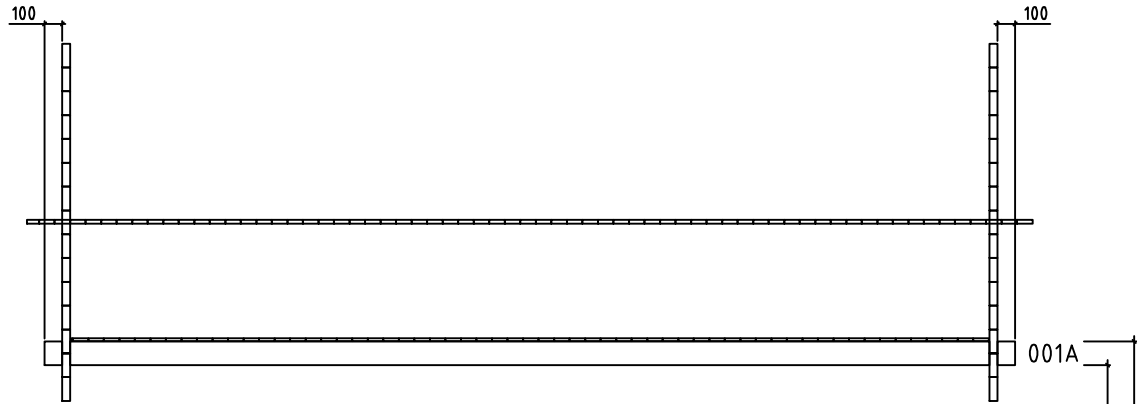

Wall-Wand 7 ↗

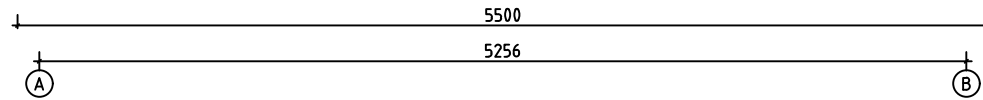

Model	0laug44ISO	Page	10
Client		Scale	1:40
Material	4.4x13.5	Date	26.08.2020
Company		File	0laug44ISO.dwg

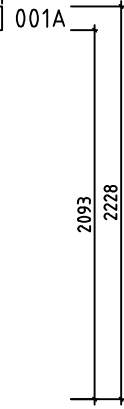
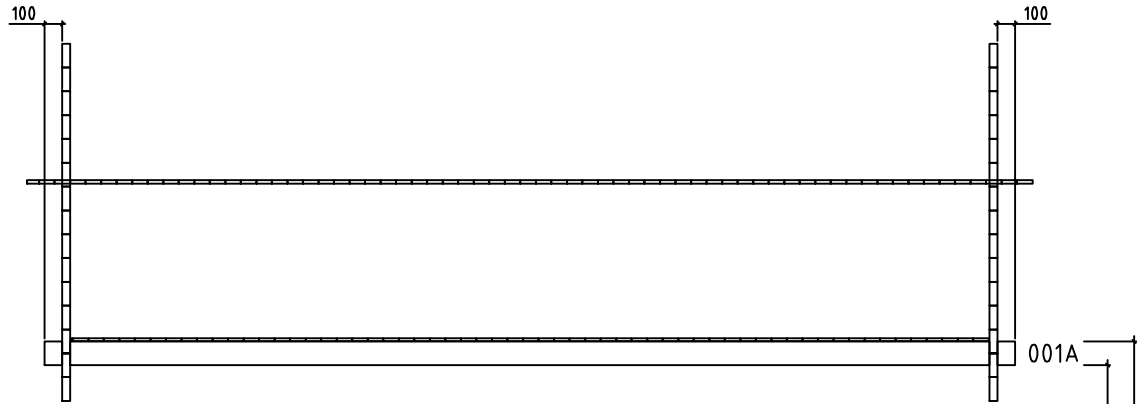

Wall-Wand 8 ↗

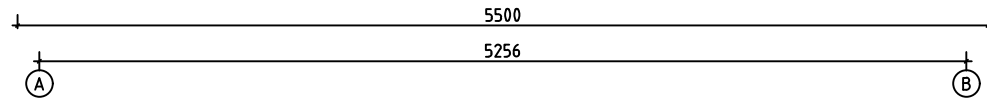

Model	Olaug44ISO	Page	11
Client		Scale	1:40
Material	4.4x13.5	Date	26.08.2020
Company		File	Olaug44ISO.dwg

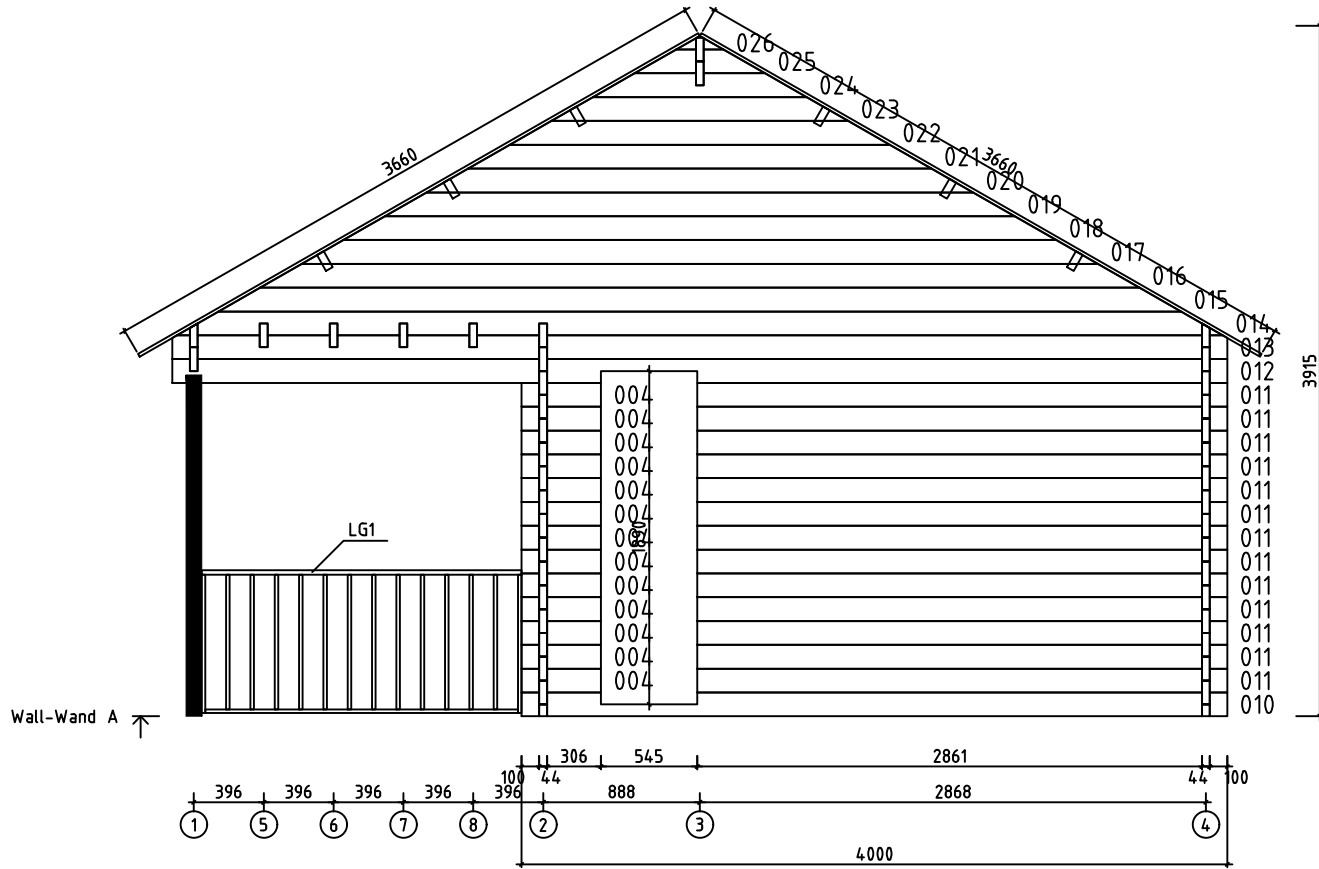

Model	0laug44ISO	Page	2
Client		Scale	1:40
Material	4.4x13.5	Date	26.08.2020
Company		File	0laug44ISO.dwg

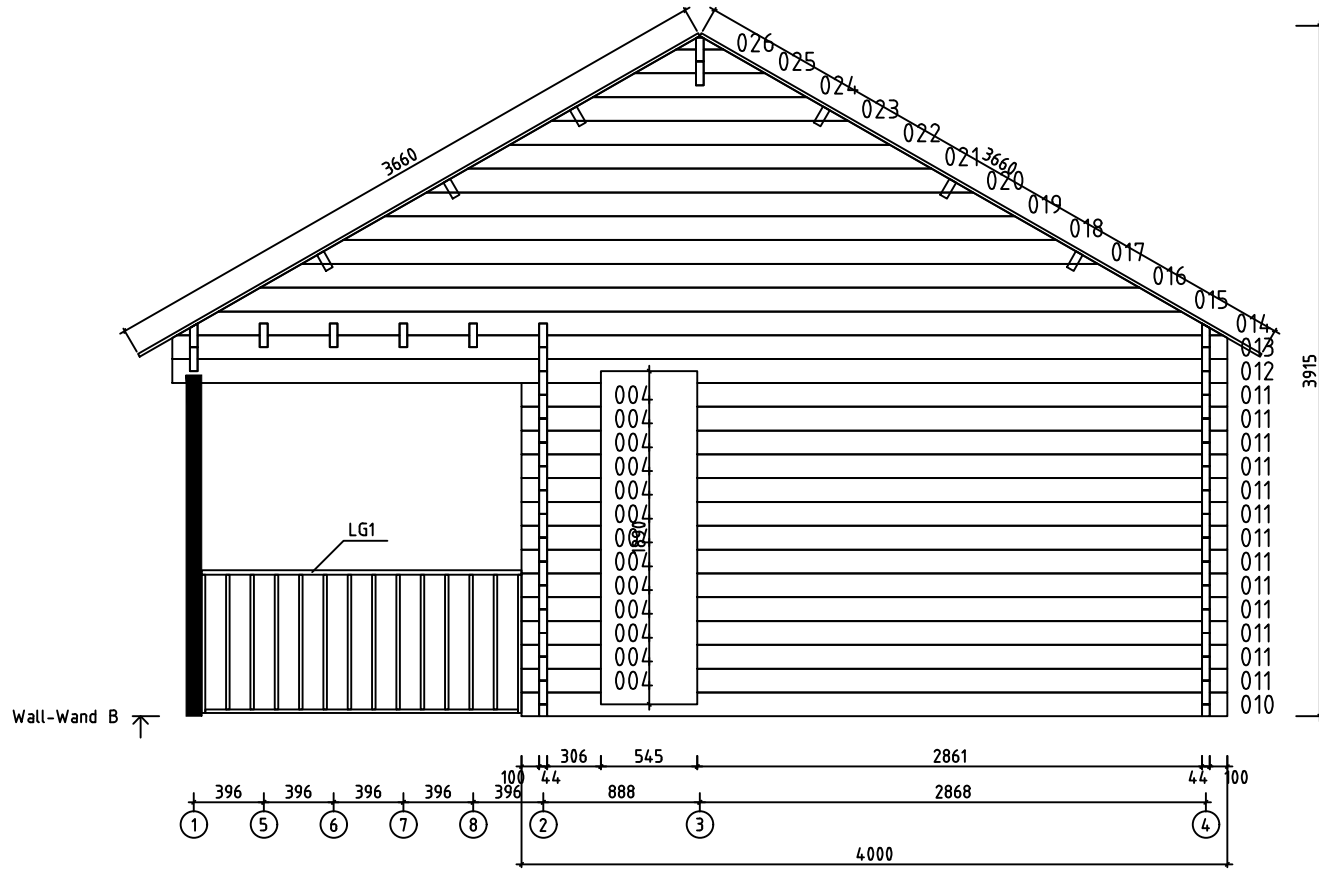

Model	0laug44ISO	Page	3
Client		Scale	1:40
Material	4.4x13.5	Date	26.08.2020
Company		File	0laug44ISO.dwg

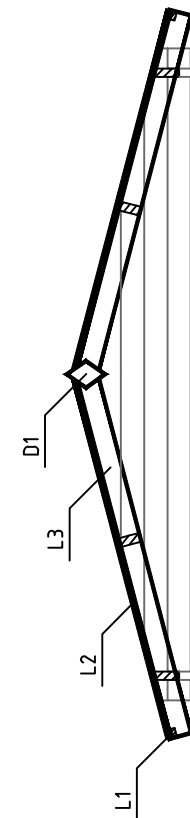
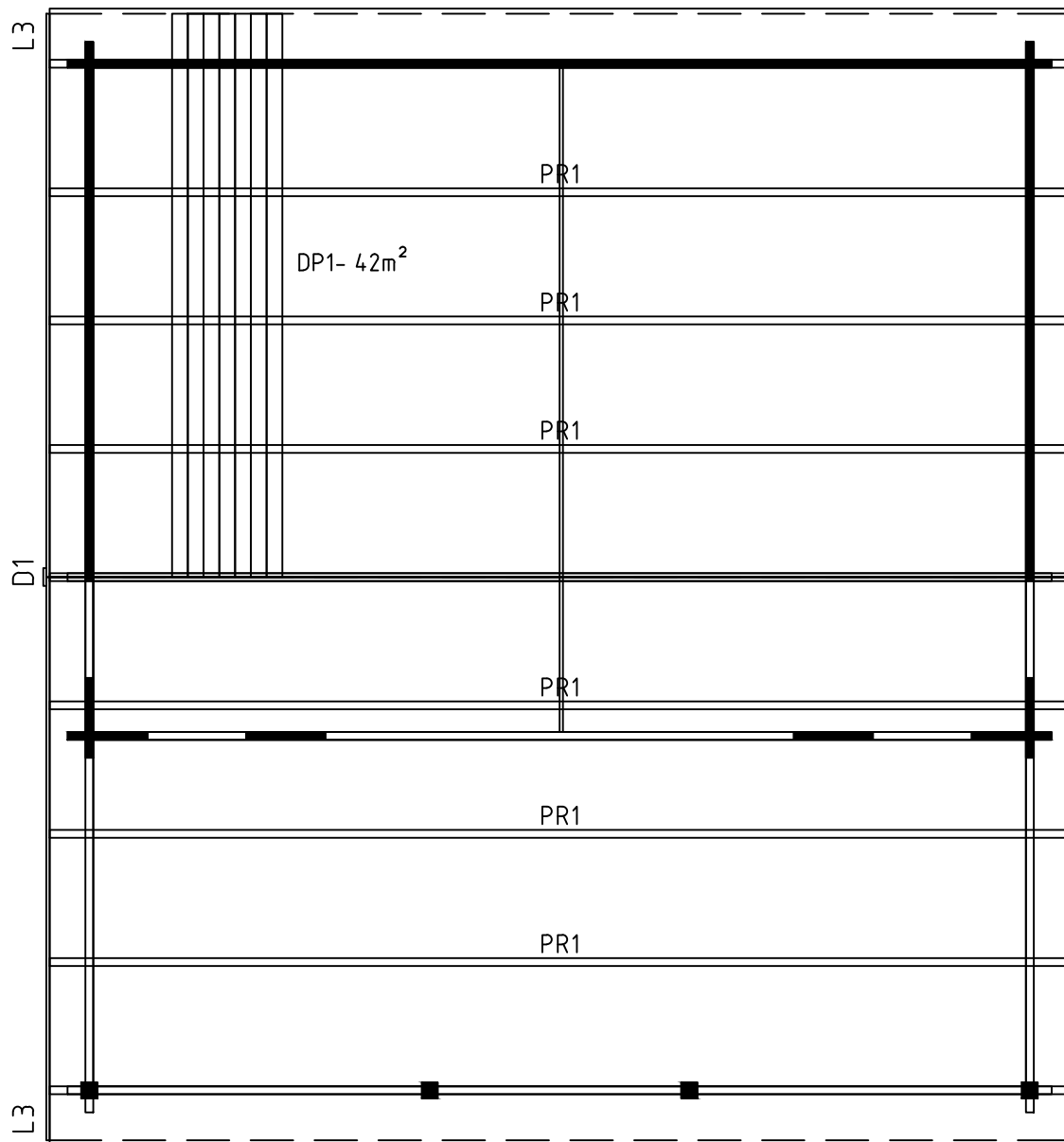

Model	Olaug44ISO	Page	ROOF
Client		Scale	1:40
Material	44x135	Date	26.08.2020
Company		File	Olaug44ISO.dwg



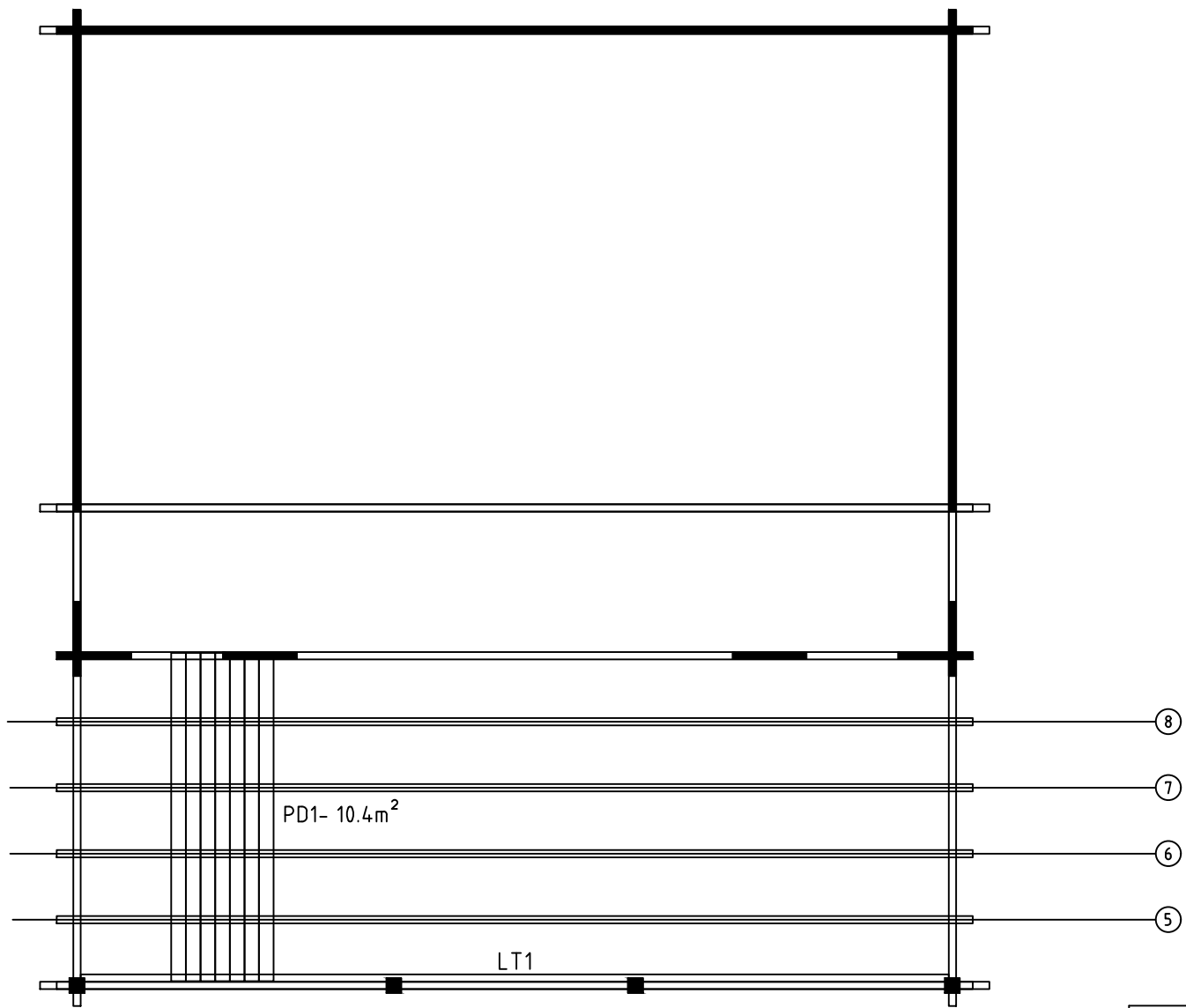

Model	Olaug44ISO	Page	ROOF
Client		Scale	1:40
Material	44x135	Date	26.08.2020
Company		File	Olaug44ISO.dwg

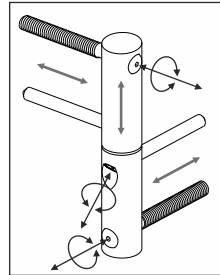
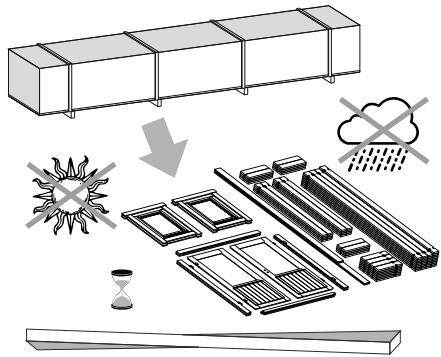
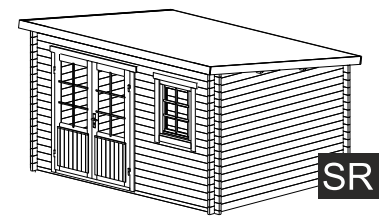
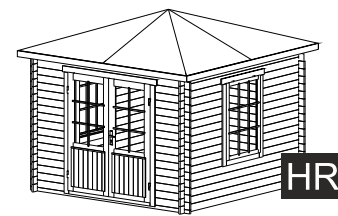
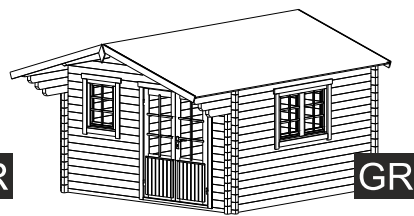
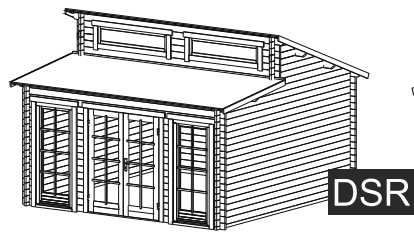
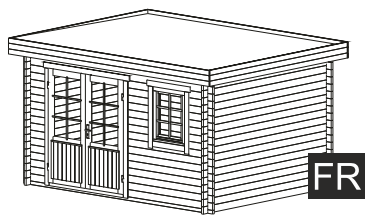

ADJUSTABLE HINGES

3.

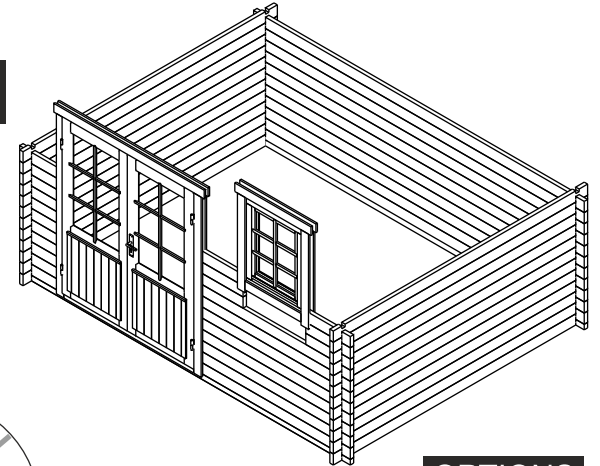

1.

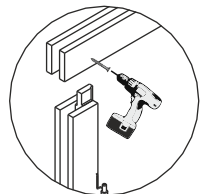
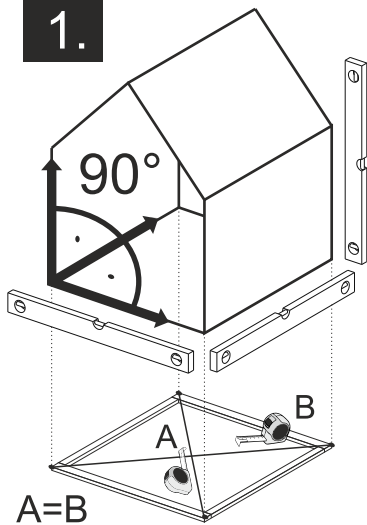

TYPE- B  
4x60

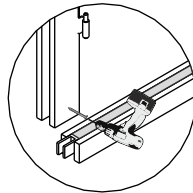

TYPE- A  
5x70

2.

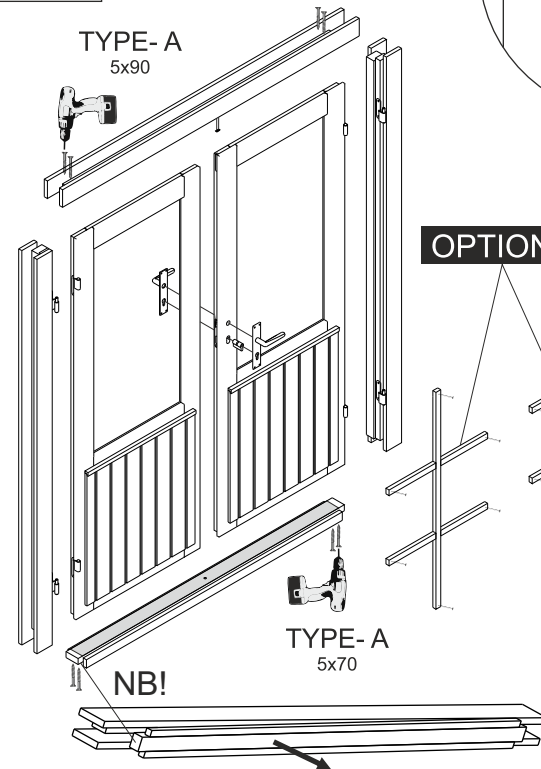

OPTIONS

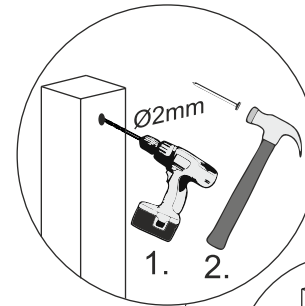

1. 2.

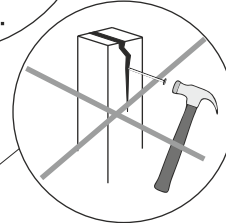

4.

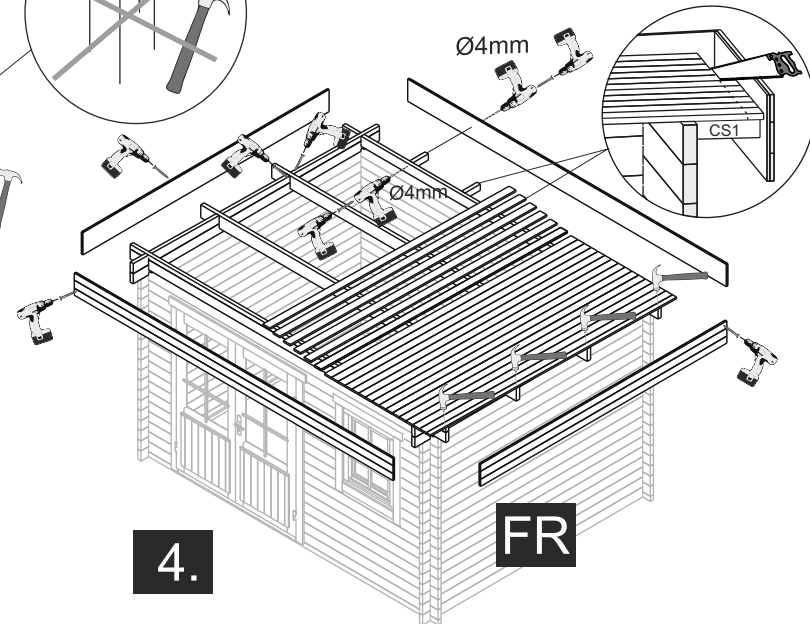

OPTIONS

FR

The guide is illustrative. This guide is not project specification.  
Der Leitfaden ist illustrativ. Dieser Leitfaden ist keine Projektspezifikation.  
De gids is illustratief. Deze gids is geen projectspecificatie.

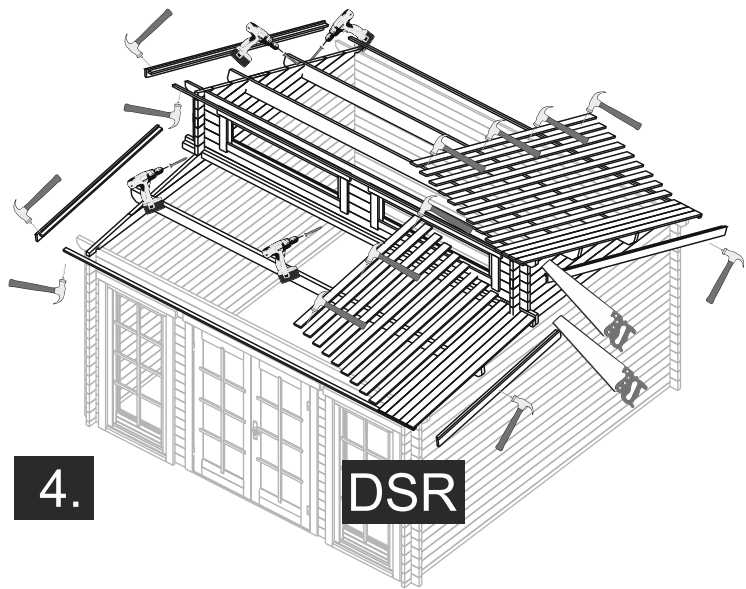

**DSR**

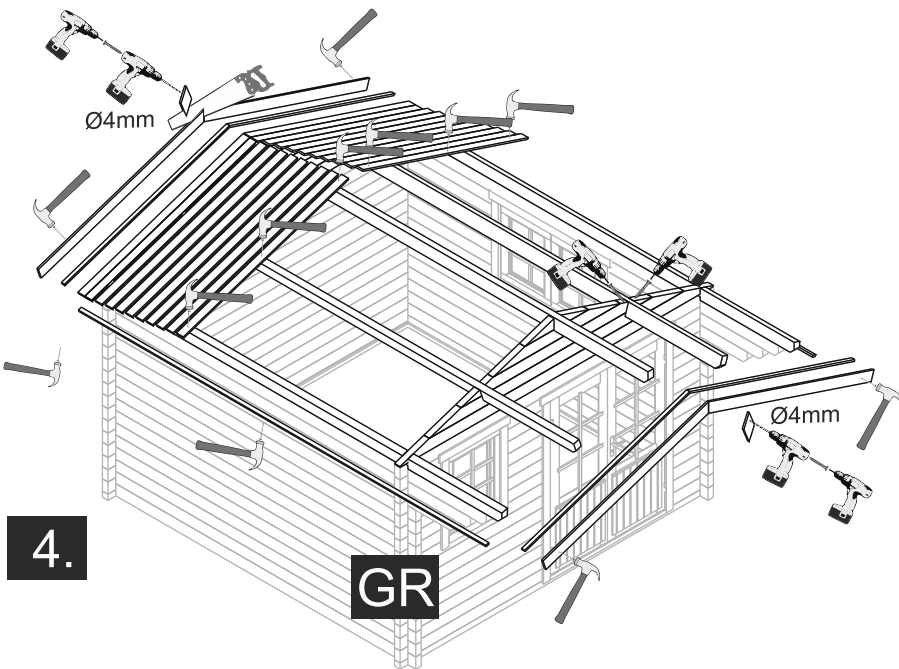

**GR**

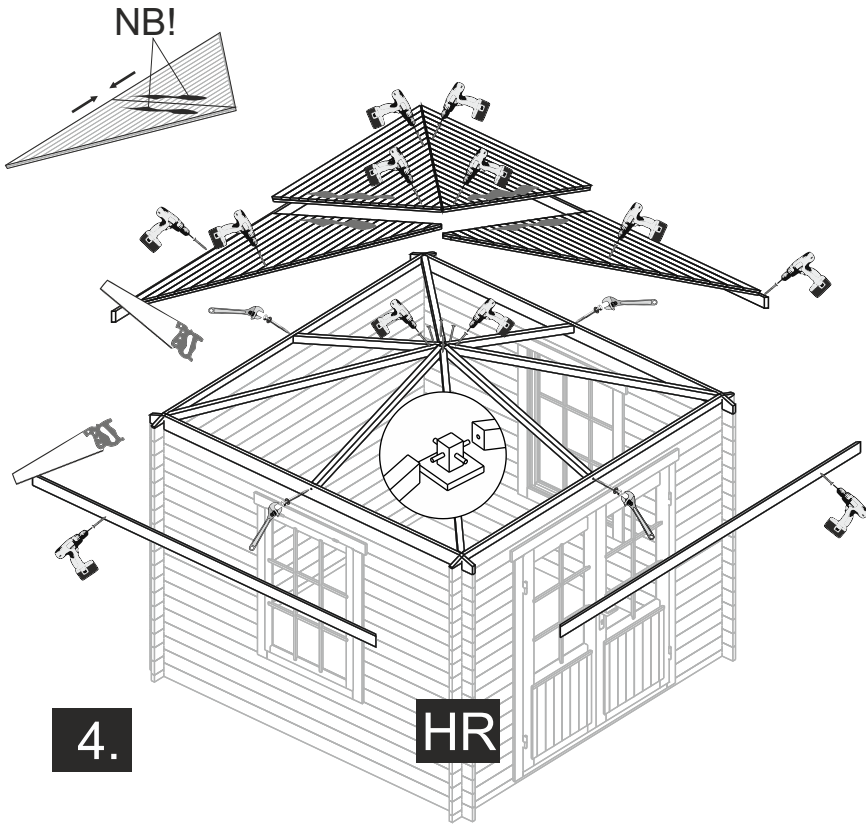

**HR**

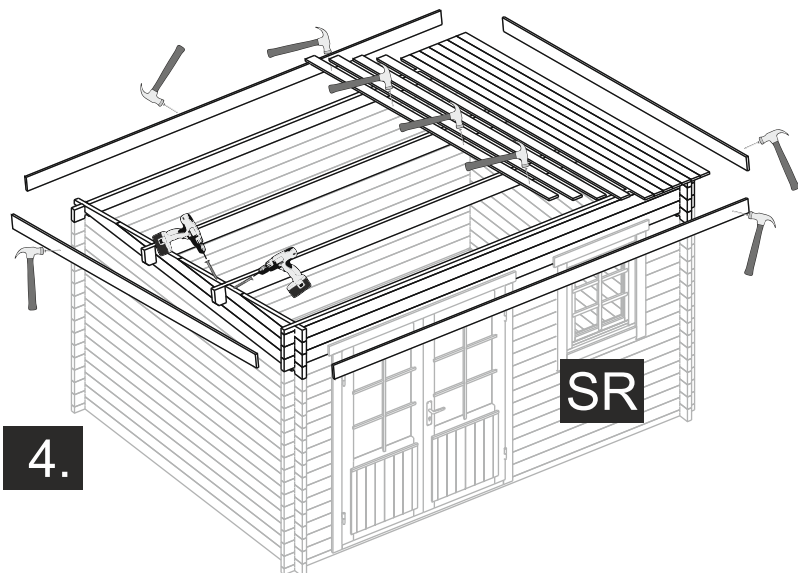

**SR**

**OPTIONS**

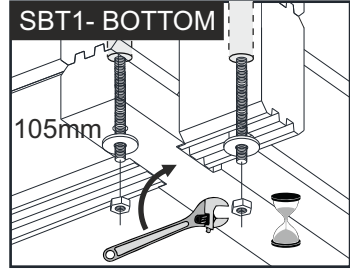
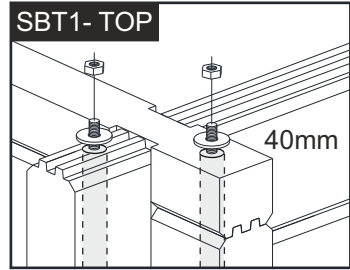
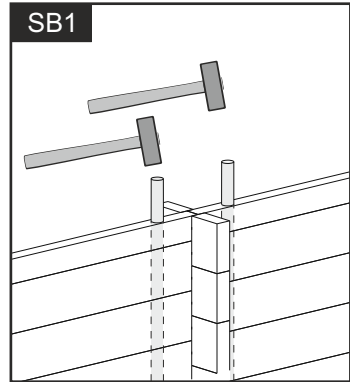

## Cutting support post / Schneiden der Stützpfeiler

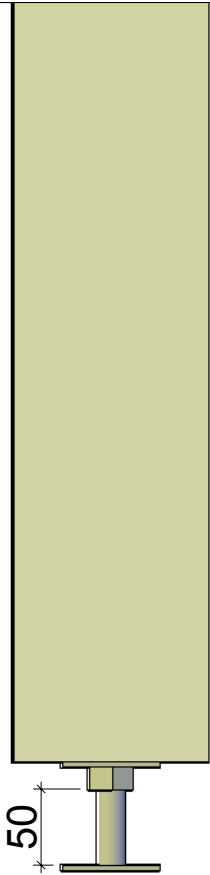

- \* Adjustment space for post support should be at least 50mm.
- \* Einstellraum für die Pfostenstütze muss mindestens 50mm sein.

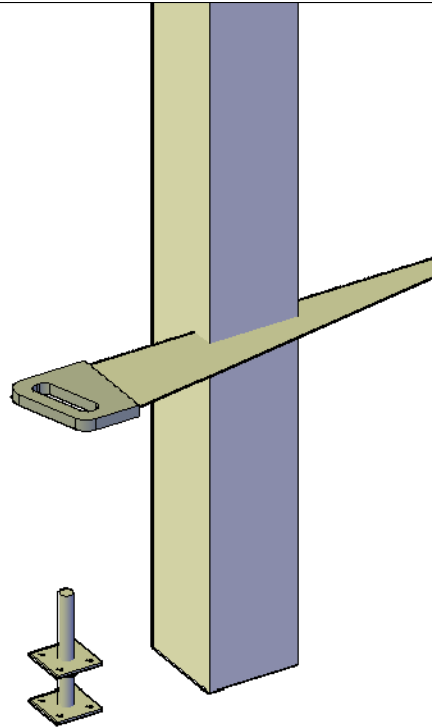

- \* Support post has extra length for various conditions. Must be sawn to suitable length on spot considering local conditions.
- \* Stützpfeiler hat extra Länge für verschiedene Bedingungen. Muss vor Ort unter Berücksichtigung der örtlichen Gegebenheiten zu einer geeigneten Länge gesägt werden.

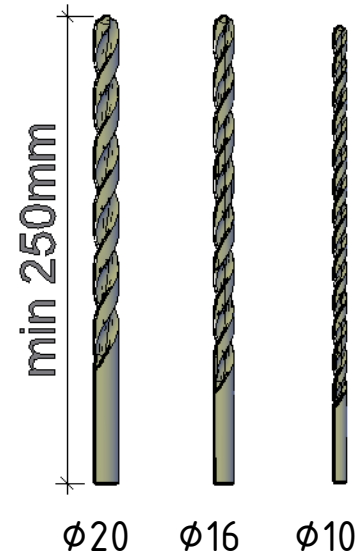
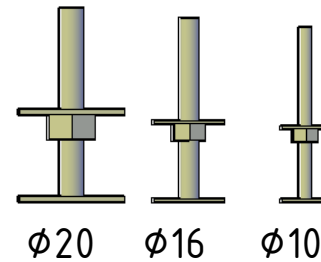

- \* In some cases you need to drill a new hole for a post support. Find a matching drill bit.
- \* In einigen Fällen müssen Sie ein neues Loch für die Pfostenstütze bohren. Finden Sie hier den passenden Bohrer.

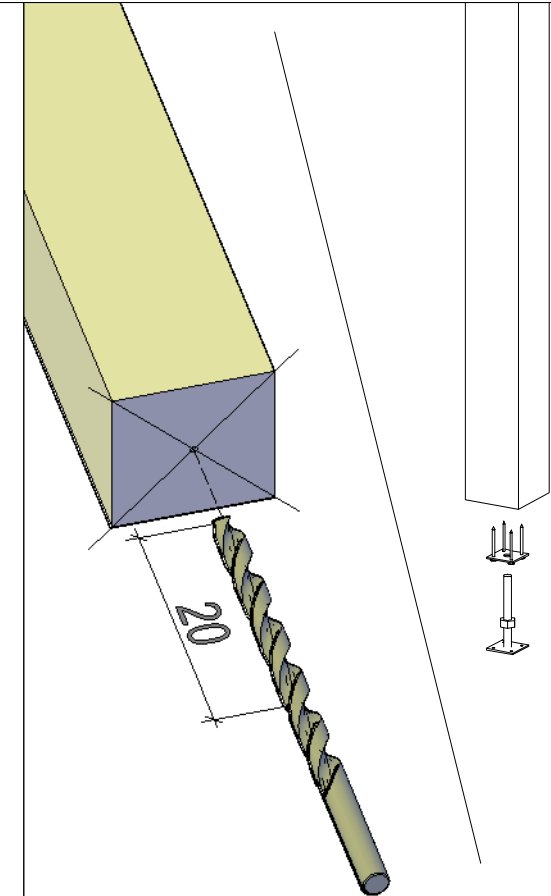

- \* Mark the center of the post and drill a new 20cm deep hole. Continue building.
- \* Markieren Sie die Mitte des Pfeilers und bohren Sie ein neues 20cm tiefes Loch. Danach mit Aufbau weiter machen.