

Name	Olson 300x430+275/44		
Zeichnung/Drawing	3D		
Profil/Profile	4.4x13.5	Datum/Date	08.10.2019

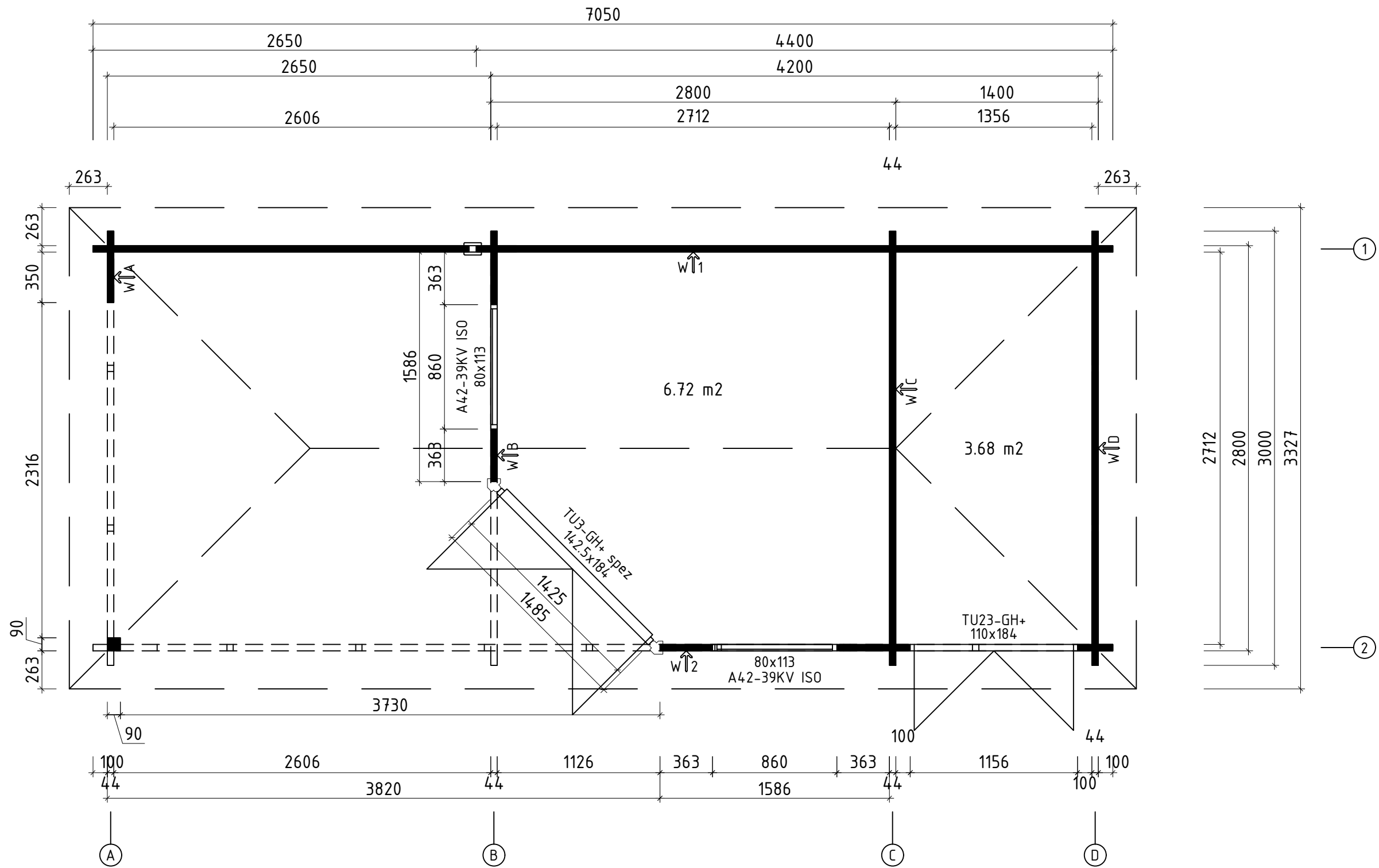

Name	Olson 300x430+275/44		
Zeichnung/Drawing	Grundplan; Plan		
Profil/Profile	4.4x13.5	Datum/Date	08.10.2019

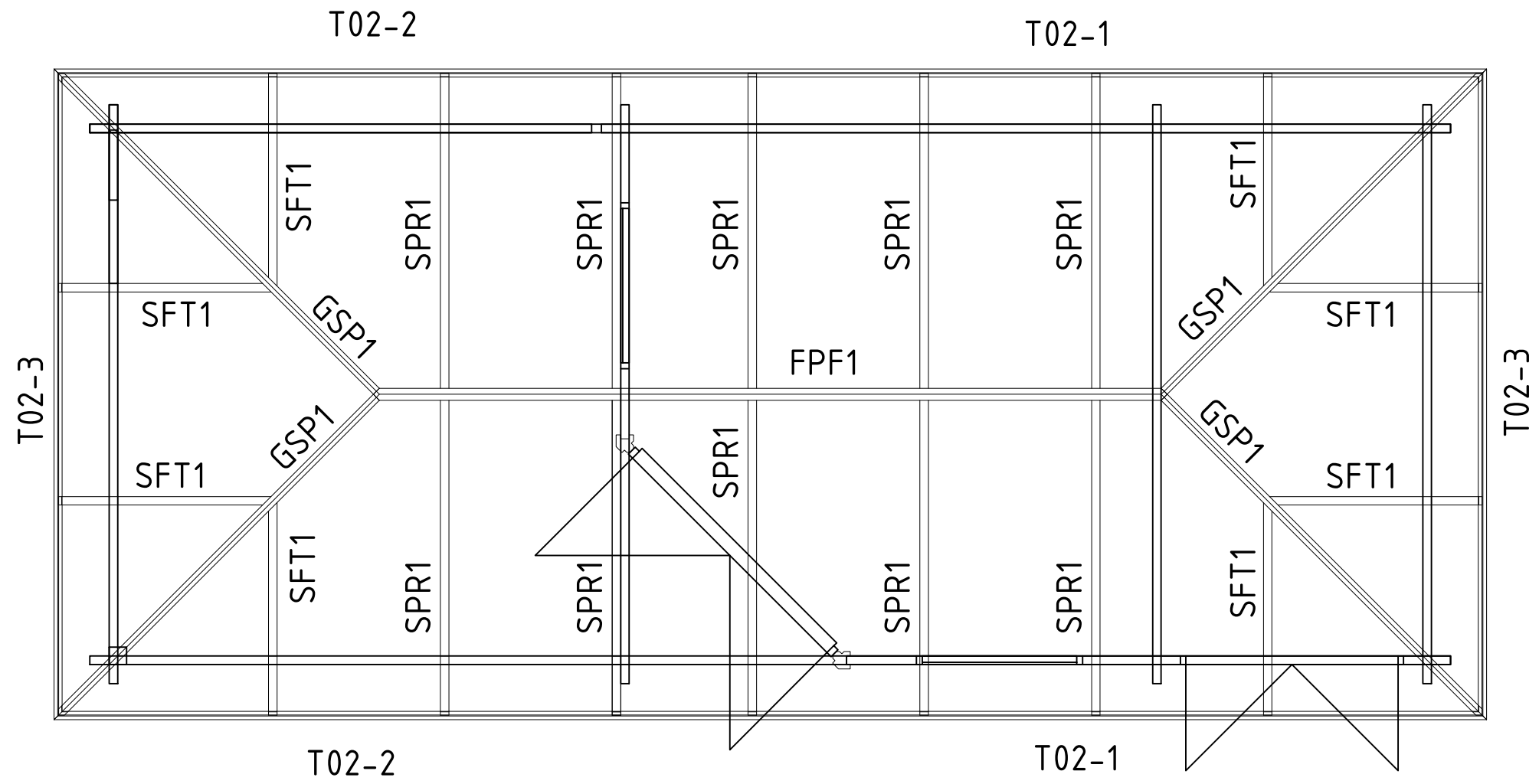

Name	Olson 300x430+275/44		
Zeichnung/Drawing	Dachplan; Roof plan		
Profil/Profile	4.4x13.5	Datum/Date	08.10.2019

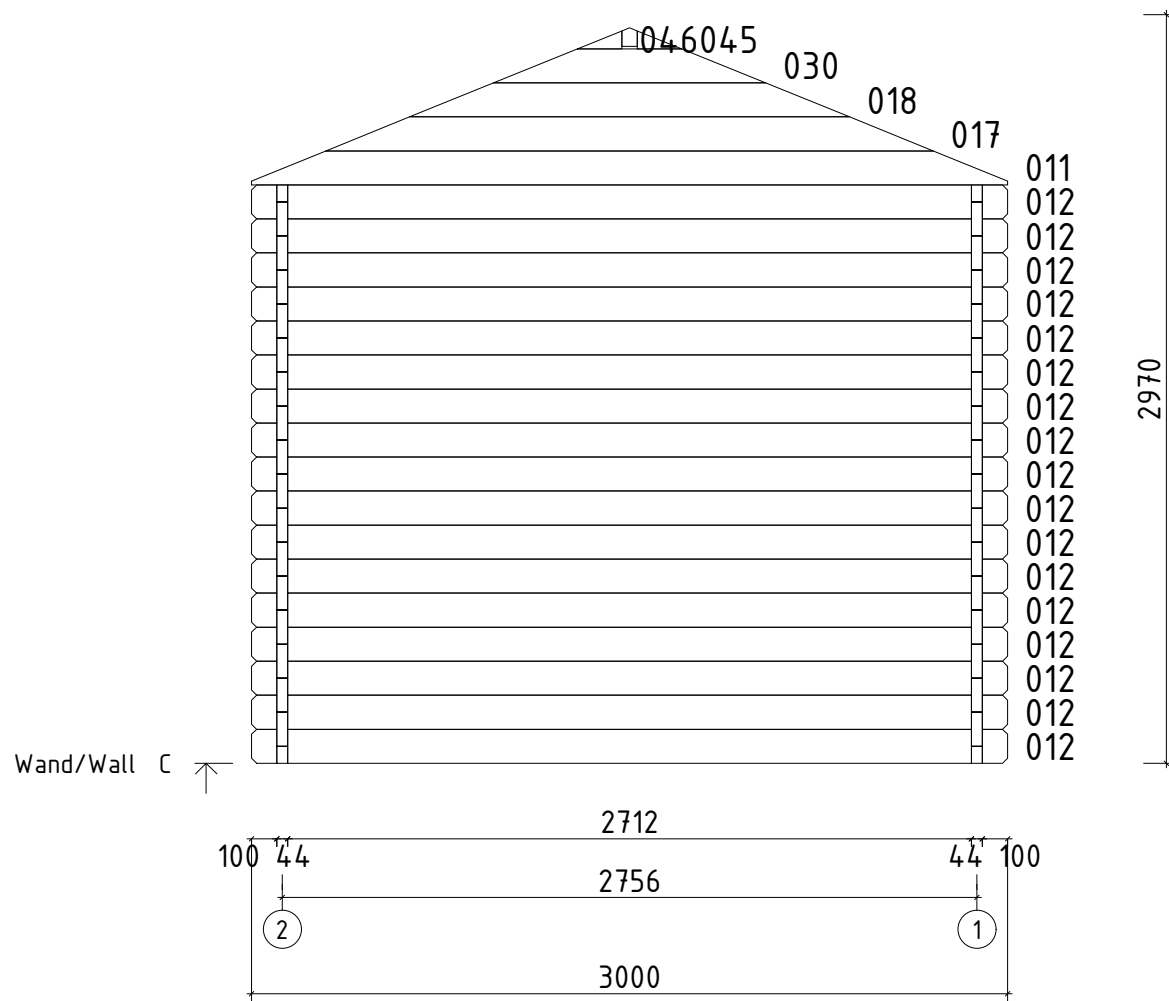



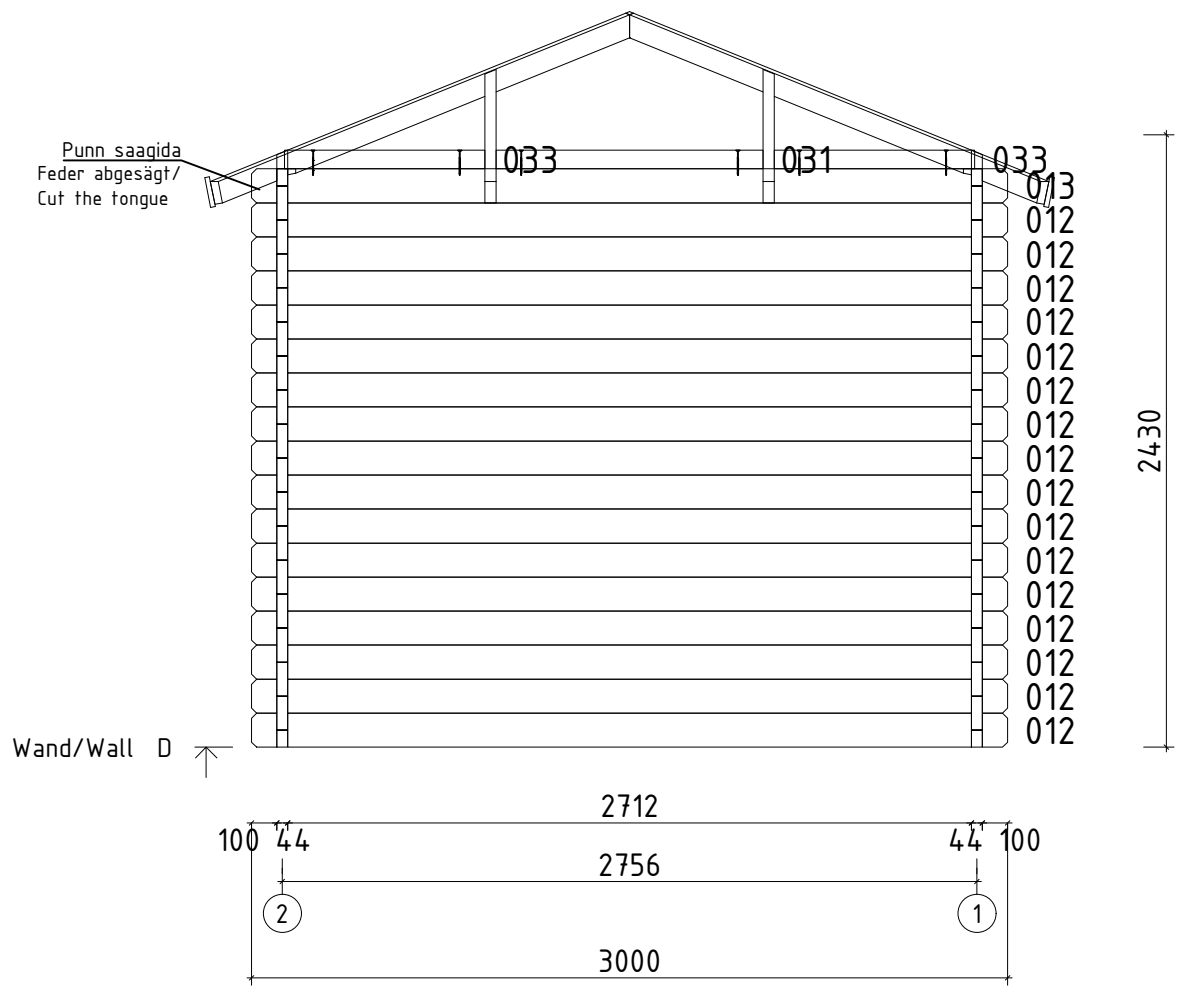



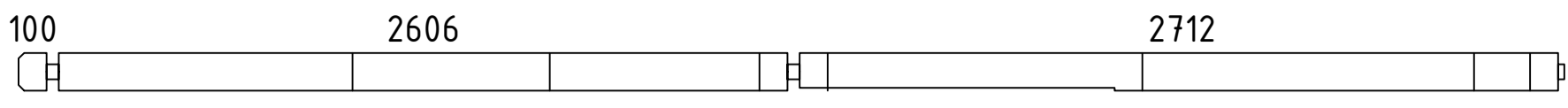
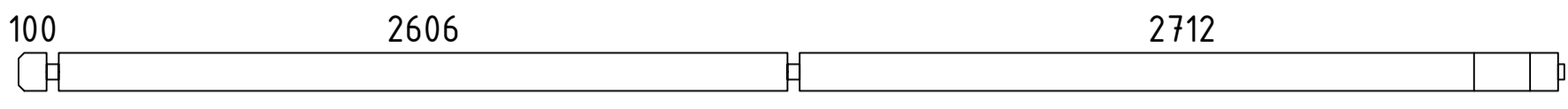
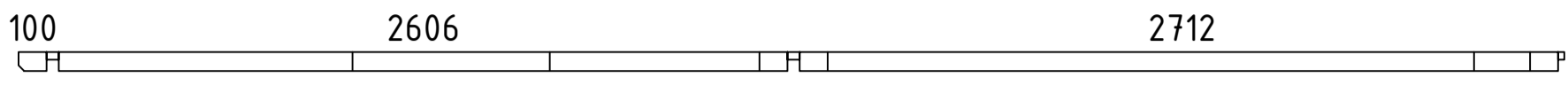
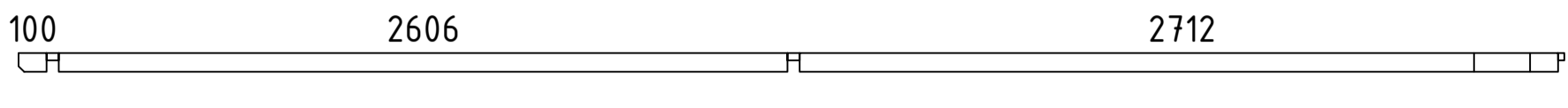
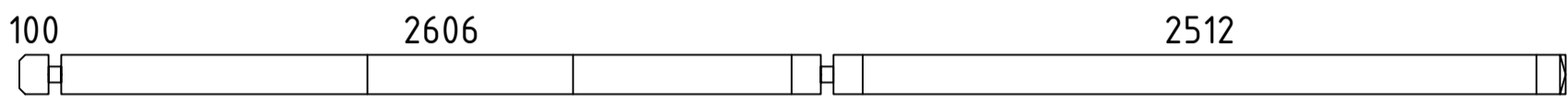
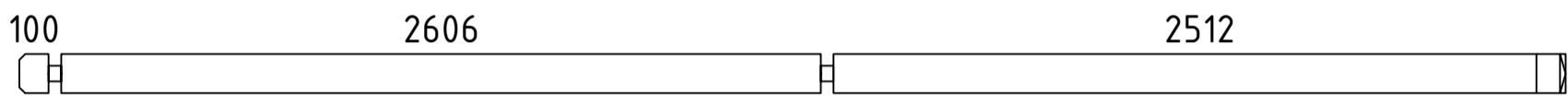
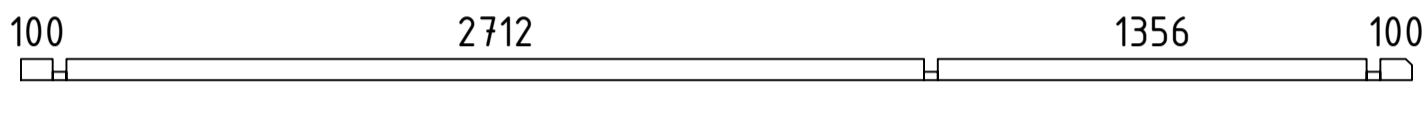
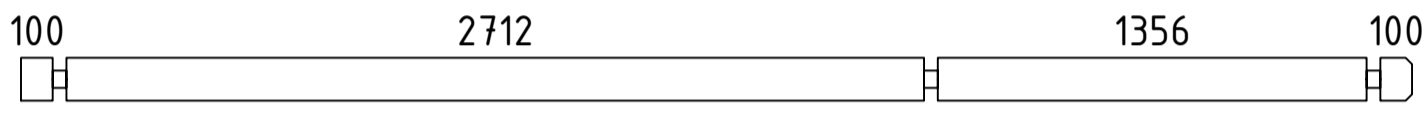
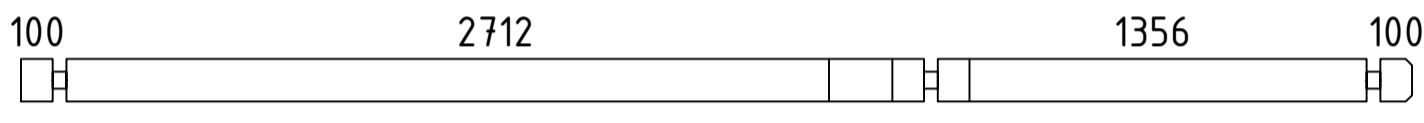
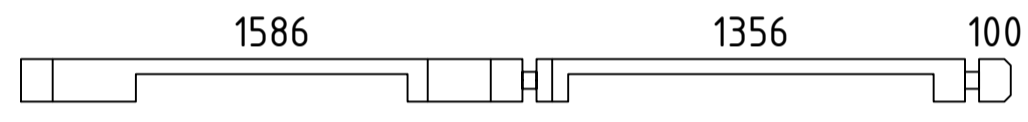
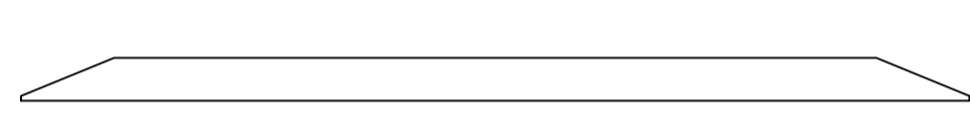
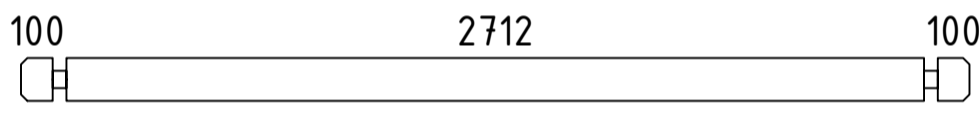
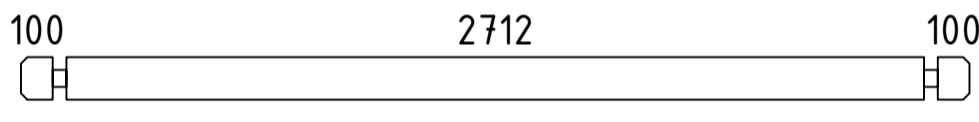
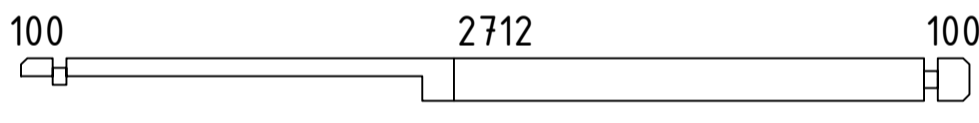
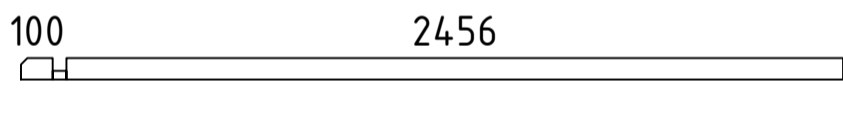
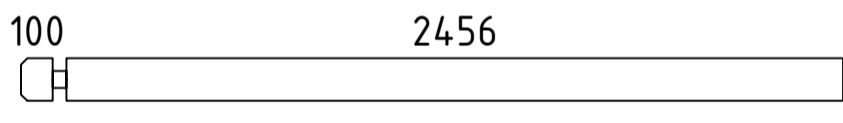
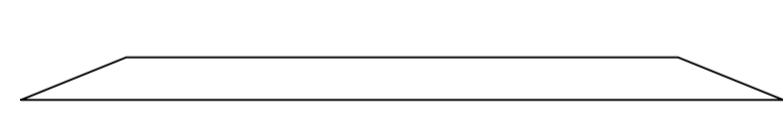
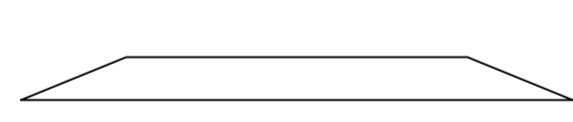
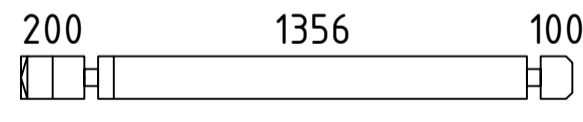
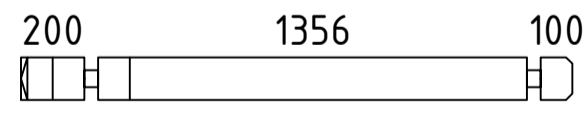
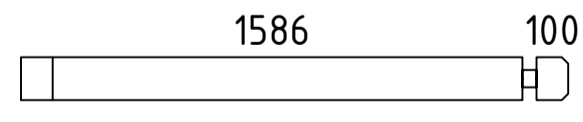
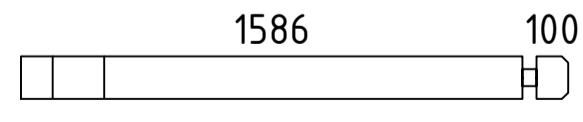
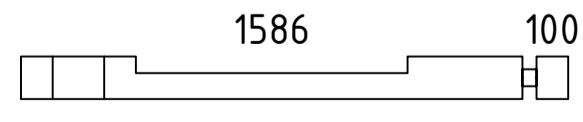
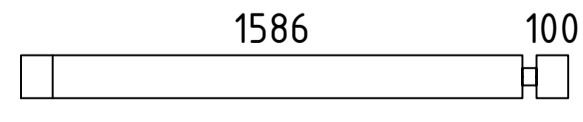
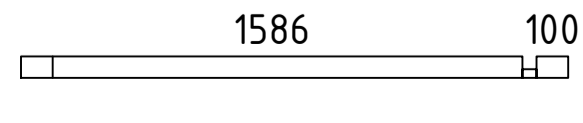



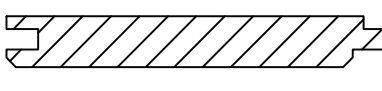
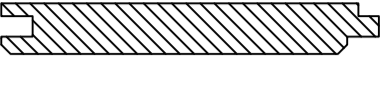
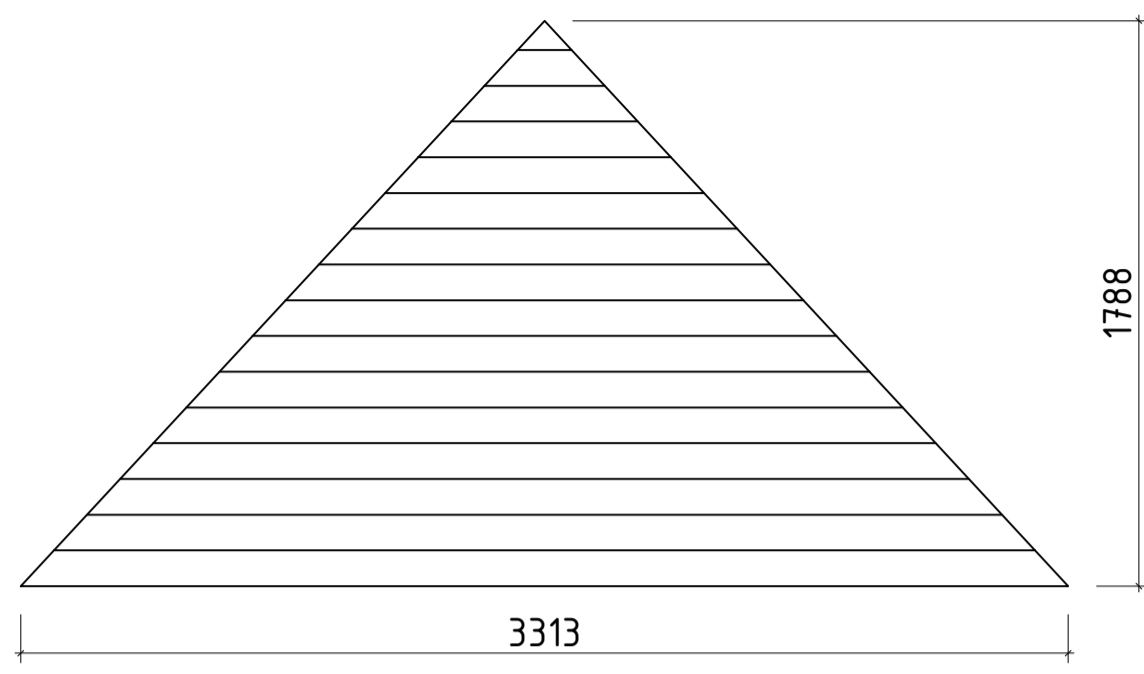

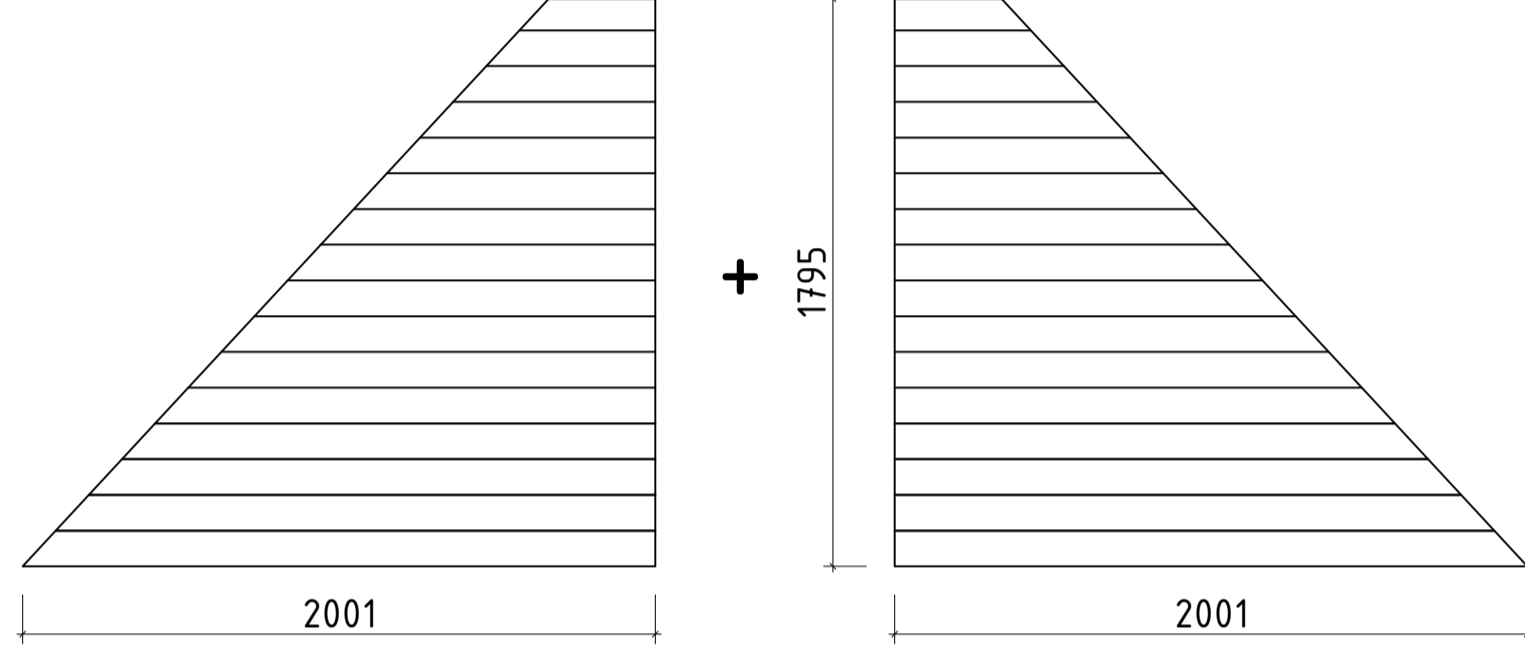
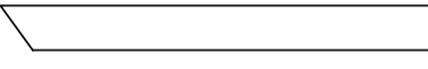
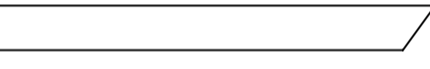
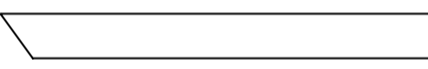
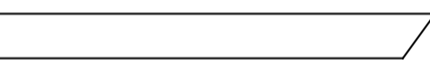
Name	Olson 300x430+275/44		
Zeichnung/Drawing	WAND/WALL C		
Profil/Profile	4.4x13.5	Datum/Date	08.10.2019

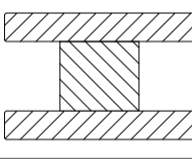
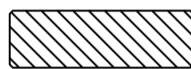
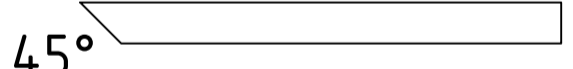
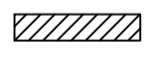

Name	Olson 300x430+275/44		
Zeichnung/Drawing	WAND/WALL D		
Profil/Profile	4.4x13.5	Datum/Date	08.10.2019

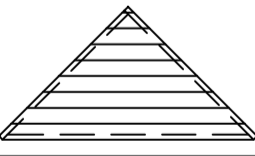
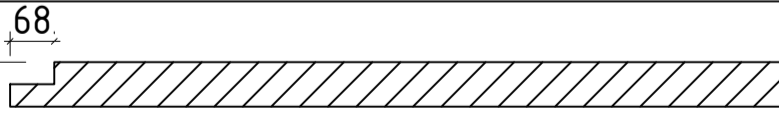
Pos	Teileliste/Specification Olson 300x430+275/44	Stck. Pcs.	Profil Profile (mm)	Länge Length (mm)
001		1	44x135	5528
002		1	44x135	5528
003		1	44x68	5528
004		1	44x68	5528
005		1	44x135	5306
006		1	44x135	5306
007		1	44x68	4400
008		13	44x135	4400
009		1	44x135	4400
010		1	44x135	3130
011		2	44x135	3000
012		37	44x135	3000
013		2	44x135	3000
014		1	44x135	3000
015		1	44x68	2600
016		14	44x135	2600
017		2	44x135	2411
018		2	44x135	1745
019		1	44x135	1744
020		1	44x135	1744
021		4	44x135	1730
022		1	44x135	1730
023		1	44x135	1730
024		4	44x135	1730
025		1	44x68	1730
Kood	Olson 300x430+275/44	Materjal	File Olson 300x430+275-44.dwg	Leht 1/4

Pos	Teileliste/Specification Olson 300x430+275/44		Stck. Pcs.	Profil Profile (mm)	Länge Length (mm)
026			1	44x68	1522
027			1	44x68	1522
028			1	44x135	1522
029			1	44x135	1522
030			2	44x135	1079
031			2	44x74	1060
032			8	44x74	846
033	Draufsicht 	✓	4+4	44x74	795
034			2	44x74	616
035			2	44x74	530
036			9	44x135	507
037			8	44x135	507
038			14	44x135	494
039			1	44x135	444
040			13	44x135	363
041			4	44x135	363
042			2	44x74	272
043			1	44x68	244
044			13	44x135	244
045			2	44x71	176
046			2	44x71	176
SPR1	SPARREN - RAFTERS 		10	44x85	1776
FPF1	FIRSTPFETTEN - RIDGE BEAMS 		1	62x105	4112
GSP1	GRATSPARREN - HIP RAFTERS 		4	44x94	2424
SFT1	SCHIFTER - JACK RAFTERS 		4+4	44x85	1205
Kood	Olson 300x430+275/44	Materjal	File	Olson 300x430+275-44.dwg	Leht 2/4

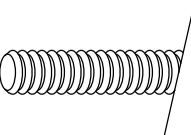
Pos	Teileliste/Specification Olson 300x430+275/44		Stck. Pcs.	Profil Profile (mm)	Länge Length (mm)
	DACHBRETTER - ROOF BOARDS 		32+1	113x16	3374
	DACHBRETTER - ROOF BOARDS  		2	113x16	
	DACHBRETTER - ROOF BOARDS  		2+2	113x16	
T02-1	TRAUFENBRETTER - EAVES BOARDS 18x120	 +  ✓	1+1	18x120	4540
T02-2	TRAUFENBRETTER - EAVES BOARDS 18x120	 +  ✓	1+1	18x120	2945
T02-3	TRAUFENBRETTER - EAVES BOARDS 18x120	 ✓	2	18x120	3440
A44-1	ADAPTER 44	 250  ✓	1	80x120	2160
DzT 58-1	ECKTÜR- Deckbrett zum Tür - CORNER DOOR- cover strip for door		1	18x58	1585
VK1-1	ECKTÜR- Verkleidungsleisten für Vordachelement - CORNER DOOR- trim strips for canopy element 58mm	 45°  ✓	2	58x12	1100
P9L2-1	ECKTÜR- linke Türpfoste - CORNER DOOR- left hand doorpost 44	 40  46	1	90x90	1980
P9R2-1	ECKTÜR- rechte Türpfoste - CORNER DOOR- right hand doorpost 44	 40  46	1	90x90	1980
VE1	ECKTÜR- Vordachelement - CORNER DOOR- canopy element 1435x745		1		
TP90-1	STÜTZPFOSTE - SUPPORT POST 90x90	 68  ✓	1	90x90	2190
ML1	Metallstange - Metal bar		1	D10	830
ML2	Metallstange - Metal bar		5	D10	770
ML3	Metallstange - Metal bar		6	D10	430
KL1	Gewindestange - Threaded Rod M8		4		338
Kood	Olson 300x430+275/44	Materjal	File	Olson 300x430+275-44.dwg	Leht 3/4

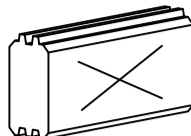
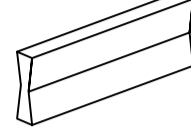
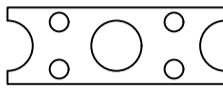
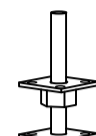
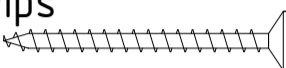
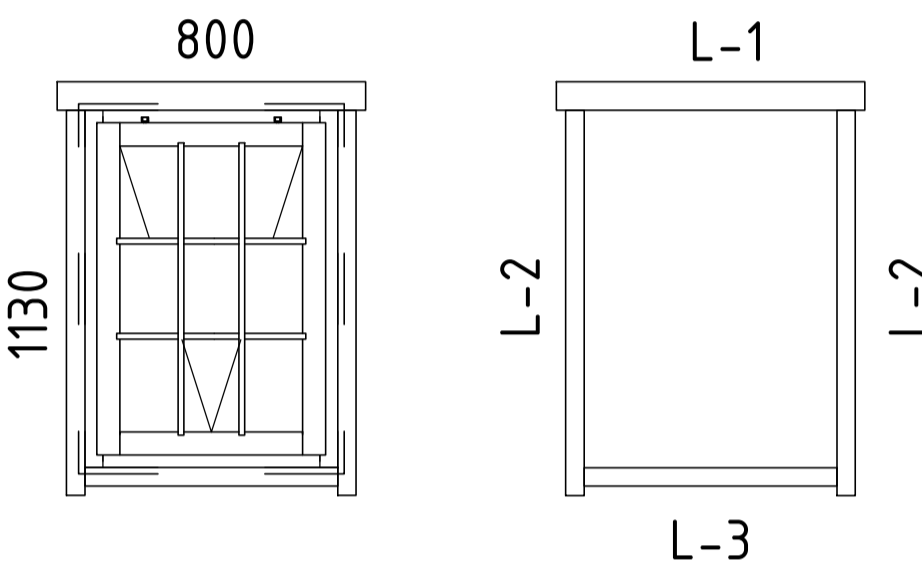
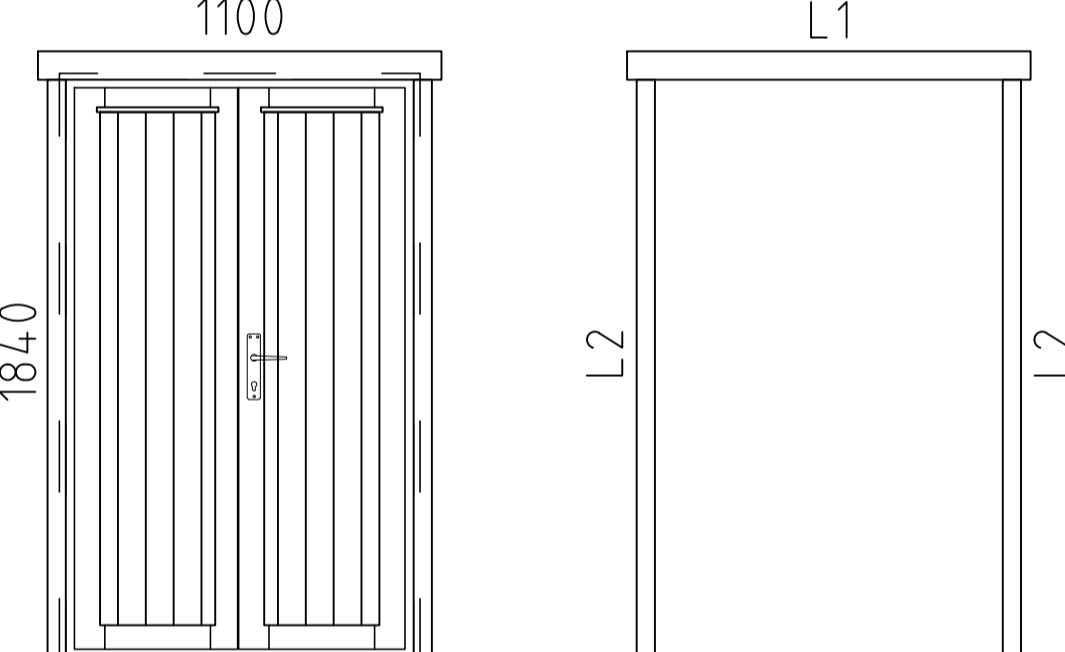
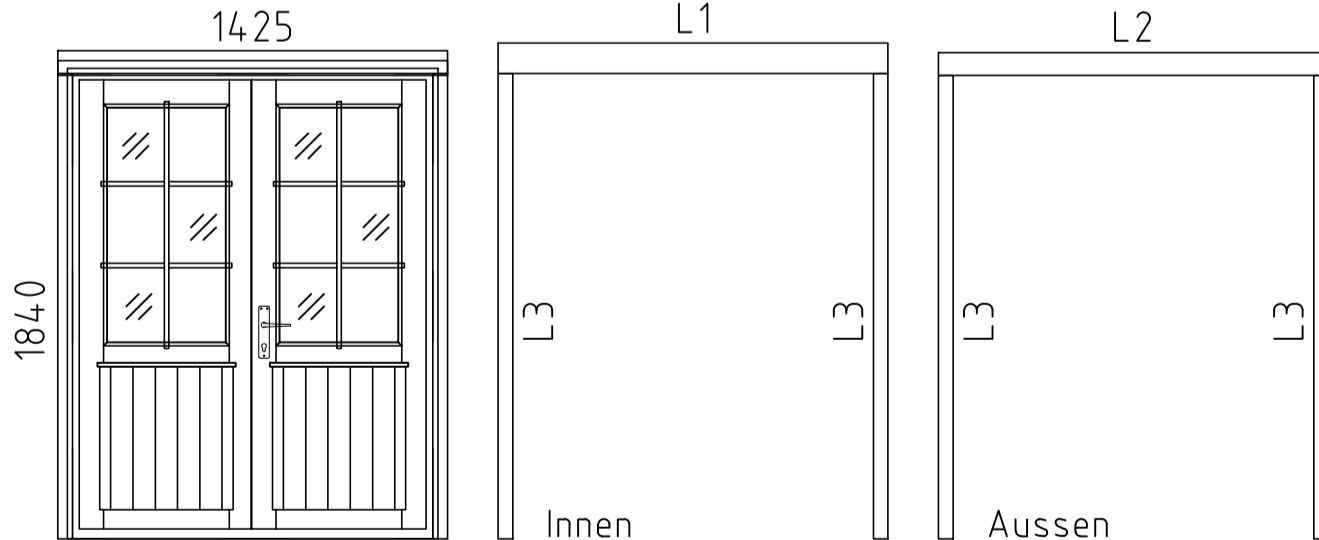
Pos	Teileliste/Specification Olson 300x430+275/44		Stck. Pcs.	Profil Profile (mm)	Länge Length (mm)
	Mutter - nut M8 U-Scheibe - washer Ø25		8		
SH	SCHLAGHÖLZER - MOUNTING PIECES		3		
HK2	HOLZ-KLOTZEN für verbinden der Wandbohlen - Wooden wedge for connecting the wall parts (122mm)		2		
VS	Verbindungsstreifen für verbinden der Wandbohlen - Connecting strip for connecting the wall parts		4		
VP2	Verstellbare Pfostenstütze - Adjustable post support M16		1		
SR37	Schrauben - Screws 3.5x45 Fenster- und Türleisten - Window and Door strips Verbindungsstreifen - Connecting strips		110		
	FENSTER/WINDOW 800x1130  <p>800 1130 L-1 L-2 L-3</p> <p>A42-39KV ISO</p> <p>L1 18x90 L=975mm 2 Stck./Pcs. L2 18x58 L=1218mm 4 Stck./Pcs. L3 18x58 L=800mm 2 Stck./Pcs. ✓</p>		2		
	TÜR/DOOR 1100x1840  <p>1100 1840 L1 L2</p> <p>TU23-GH+</p> <p>L1 18x90 L=1275mm 2 Stck./Pcs. L2 18x58 L=1840mm 4 Stck./Pcs. ✓</p> <p>DIN rechts</p>		1		
	TÜR/DOOR 1425x1840  <p>1425 1840 L1 L2 L3 Innen Aussen</p> <p>TU3-GH+ spez</p> <p>L1 18x120 L=1540mm 1 Stck. L2 18x90 L=1540mm 1 Stck. L3 18x58 L=1840mm 4 Stck. ✓</p> <p>DIN rechts</p>		1		
	✓ - Bitte selber anpassen/Please adjust itself				
Kood	Olson 300x430+275/44	Materjal	File	Olson 300x430+275-44.dwg	Leht 4/4

Step 1: Dachelement an den Wänden verschrauben.
Step 1: Screw canopy element to the wall.

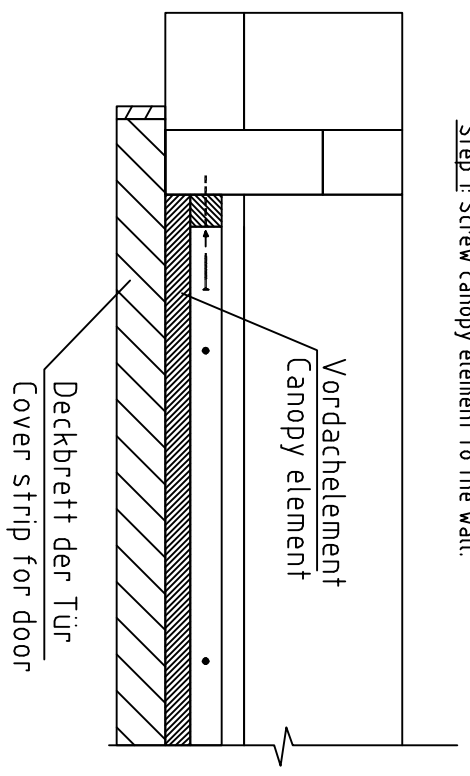

Step 2: Das Deckbrett muss von oben (durch das VD-Element) an das Dachelement verschraubt werden.
Step 2: Fasten cover strip to the canopy element.

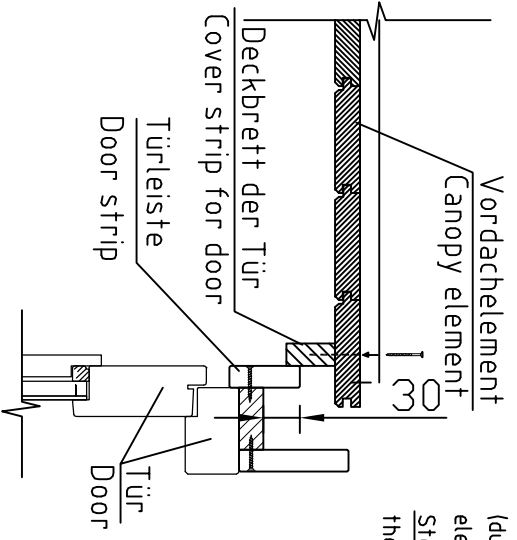

Step 3: Die Verkleidungsleisten in die richtige Länge schneiden und unter das VD-Element befestigen.
Step 3: Cut trim strips to size and fasten under the canopy element.

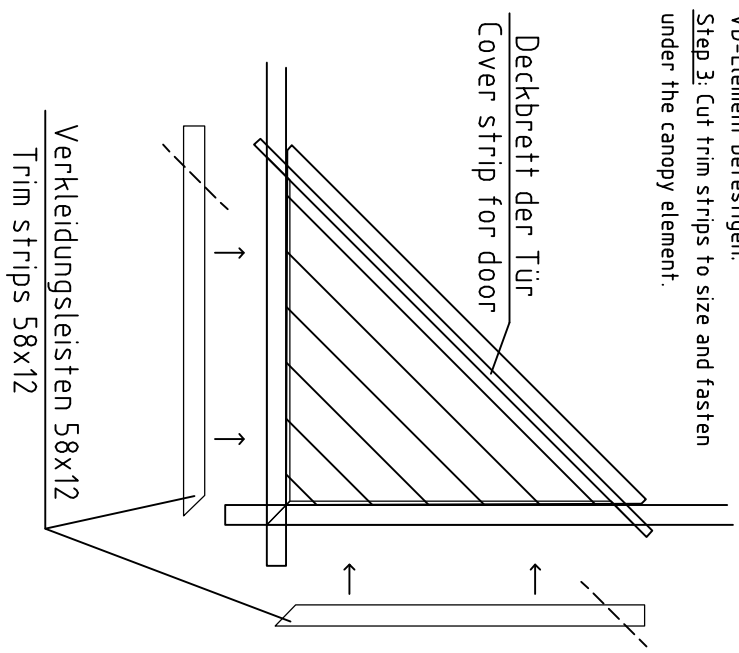

Vordachelement/Canopy element

Schnitt/Section

Cutting support post / Schneiden der Stützpfosten



* Adjustment space for post support should be at least 50mm.

* Einstellraum für die Pfostenstütze muss mindestens 50mm sein.

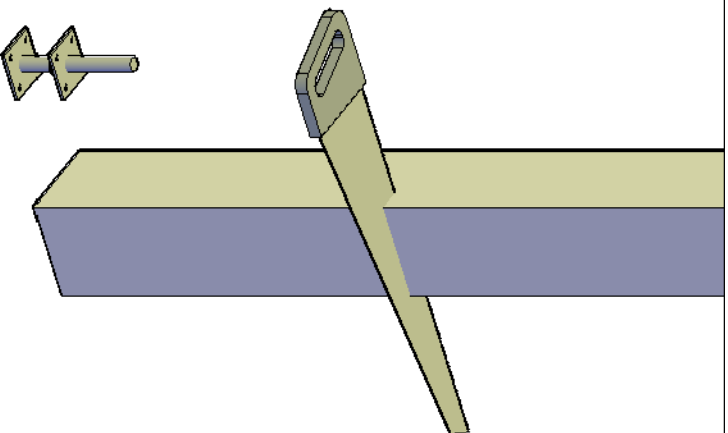

* Support post has extra length for various conditions. Must be sawn to suitable length on spot considering local conditions.

* Stützpfosten hat extra Länge für verschiedene Bedingungen. Muss vor Ort unter Berücksichtigung der örtlichen Gegebenheiten zu einer geeigneten Länge gesägt werden.

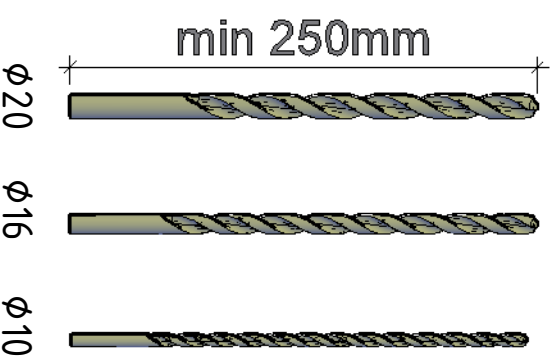
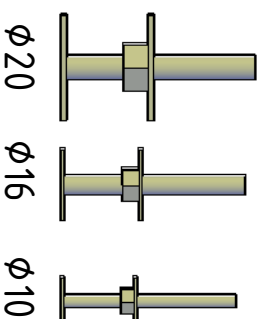

* In some cases you need to drill a new hole for a post support. Find a matching drill bit.

* In einigen Fällen müssen Sie ein neues Loch für die Pfostenstütze bohren. Finden Sie hier den passenden Bohrer.

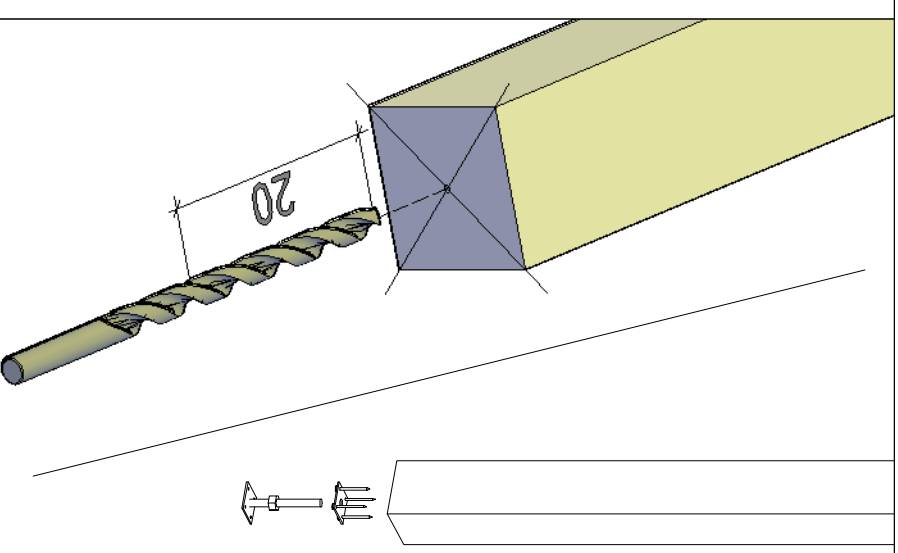

* Mark the center of the post and drill a new 20cm deep hole.

* Markieren Sie die Mitte des Pfostens und bohren Sie ein neues 20cm tiefes Loch. Danach mit Aufbau weiter machen.

Akna tüüp / Fenster typ / Window type - A68
(GH+ / SH)

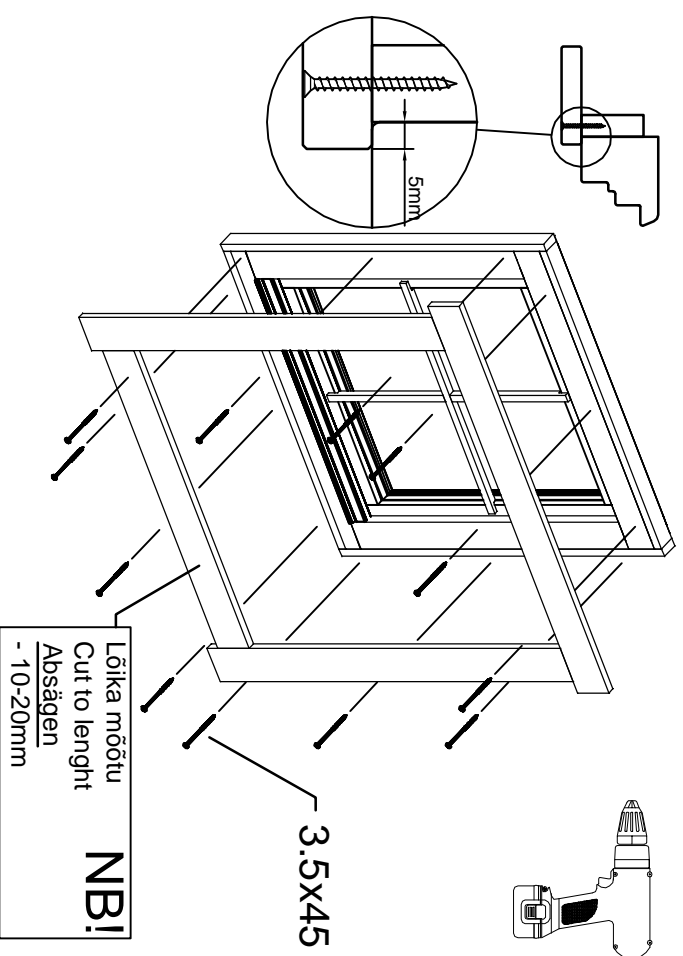
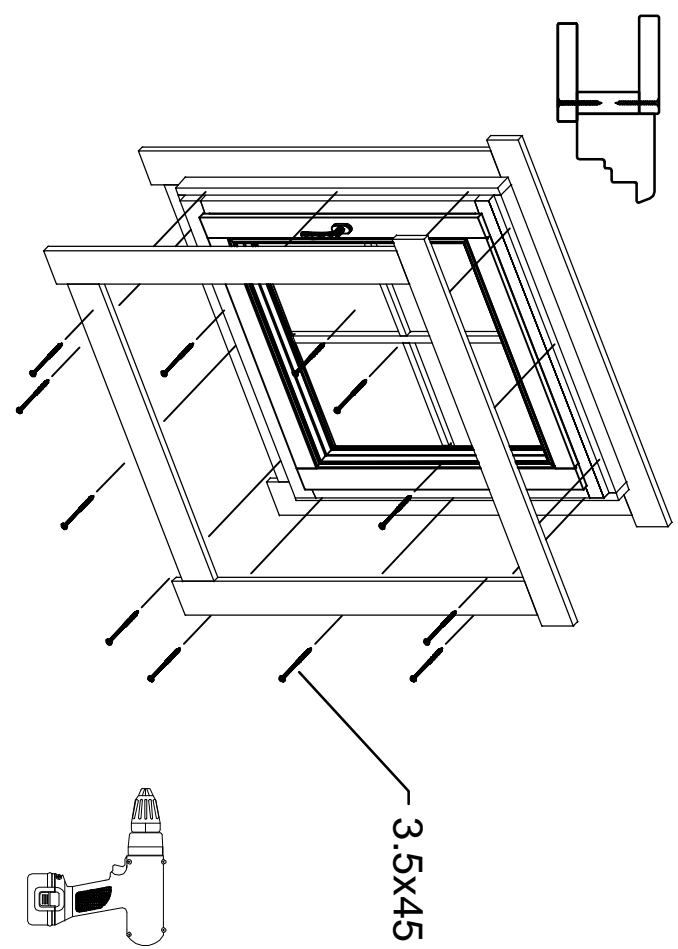
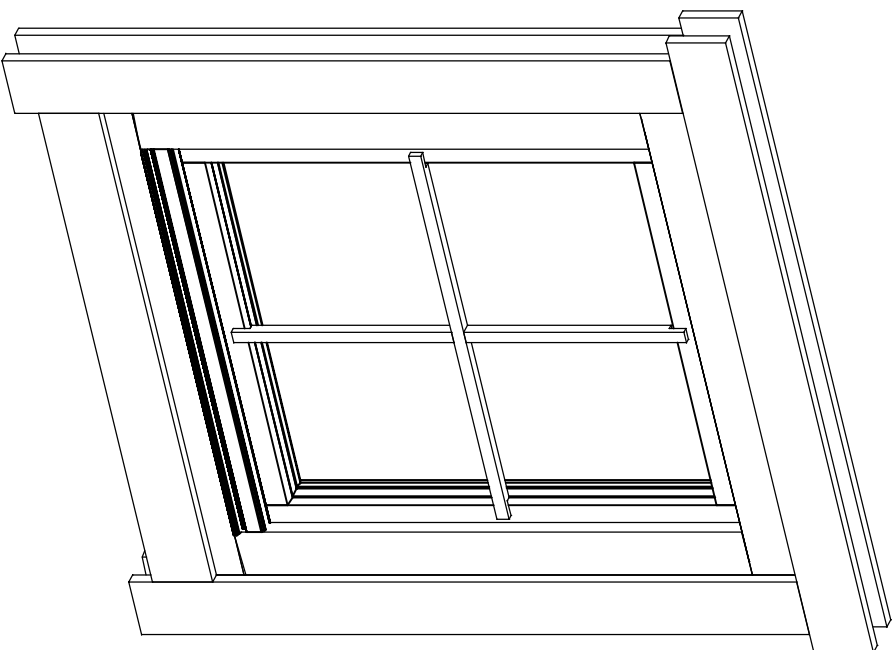

Ukse montaa 0 / Tür montage / Door assembly
(GH+ / SH)

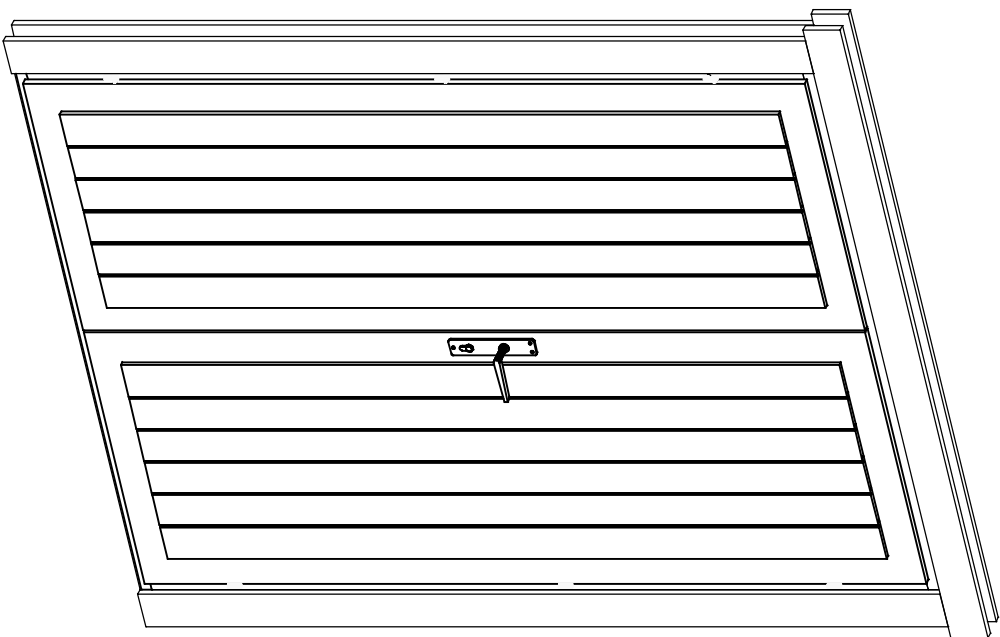

4.5x90

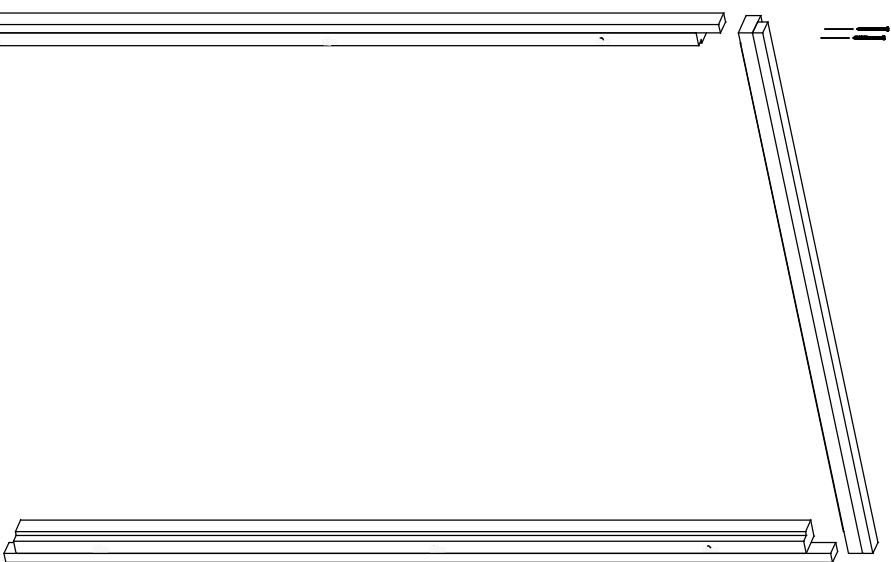

4.5x90



