













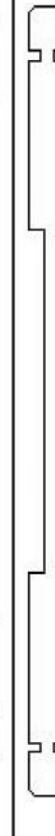

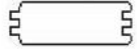

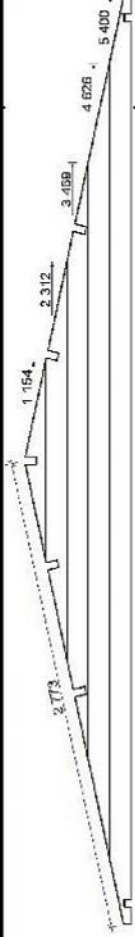

| Pos | SOUTHAMPTON 5,4 x 5,4 + 0,6 58x135 | | Profile | Length | St. |
|---------------|------------------------------------------------------------------------------------|--------------------------------------------------------------------------------------|-----------------------------------------------------------------------------------|--------|-----|
| C1 D1 |  | | 58x135 | 6000 | 2 |
| C2 D2 |  | | | 5650 | 2 |
| C4 D4 B2 |  | | | 5400 | 35 |
| A3 |  | | | 5400 | 1 |
| C5 |  | | 58x135 | 5400 | 1 |
| C6 |  | |  | 1637 | 14 |
| A2 |  | | | 1060 | 28 |
| F1 |  | | | 600 | 2 |
| A1 B1 |  | | 58 x 67 | 5400 | 2 |
| A4 B4 F2 APEX |  | | | 5400 | 3 |
| 15 | ROOFING BOARDS |  | 19 x 85 | 2880 | 142 |
| 16 | WINDOW | | 2126 x 966 | | 1 |
| 17 | Block of doors |  | 3280 x 1938 | | 1 |
| 18 | Roof of cover fixture |  | 20x120 or 20x145 | 2930 | 4 |
| 20 | Roof of cover fixture |  | 20x95 | 2950 | 4 |
| 27 | Beam |  | 40x40 | 6000 | 2 |
| 28 | ROOF JOIST |  | 58x145 | 6000 | 5 |
| 29 | Diamond |  | | | 2 |

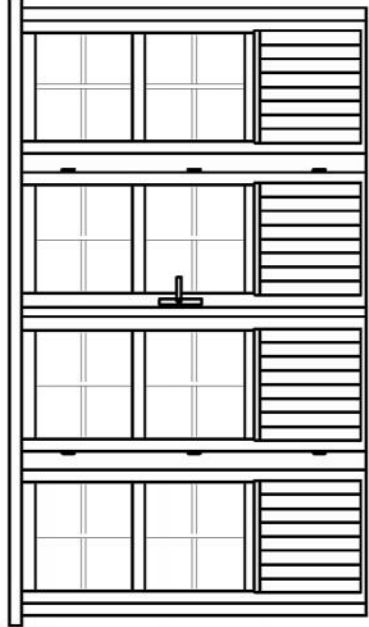
Wall B



Wall A

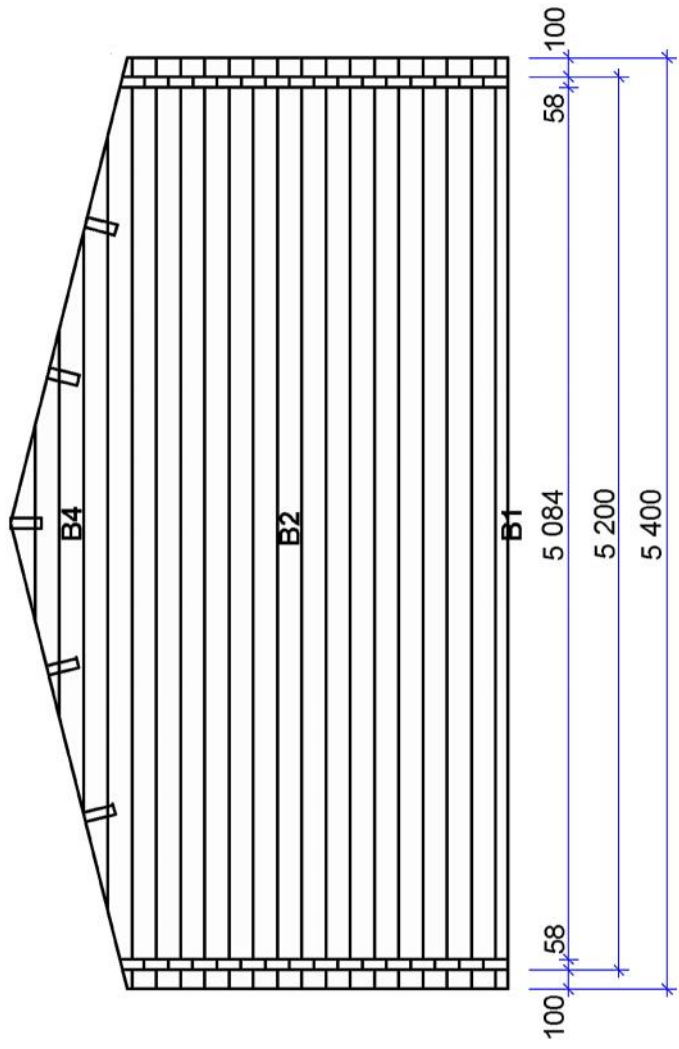
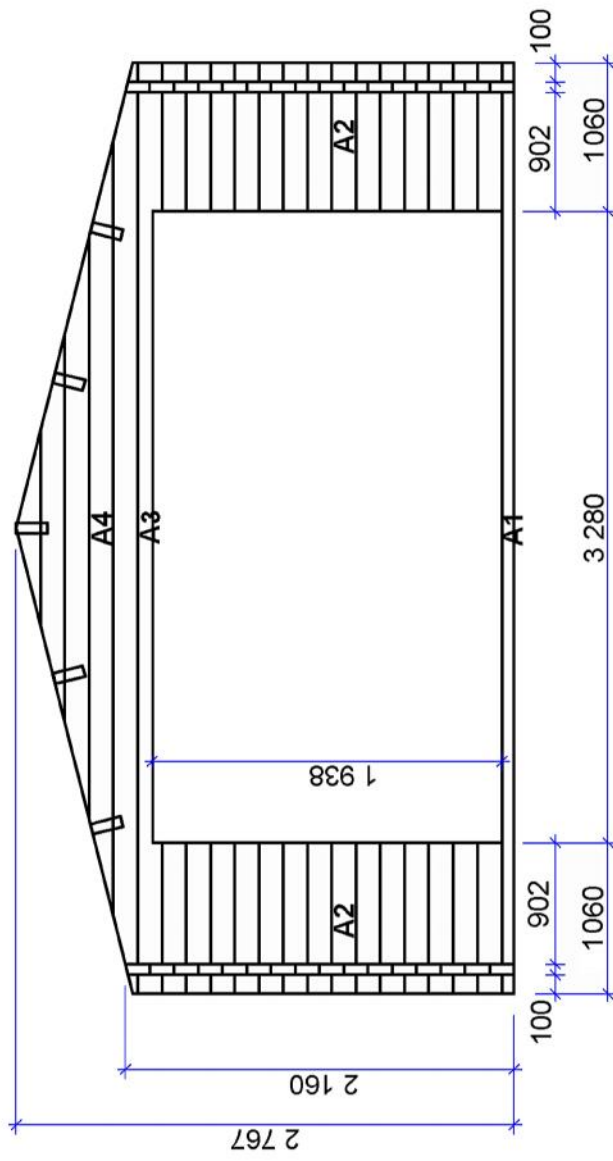

Wall F

